



This is a digital copy of a book that was preserved for generations on library shelves before it was carefully scanned by Google as part of a project to make the world's books discoverable online.

It has survived long enough for the copyright to expire and the book to enter the public domain. A public domain book is one that was never subject to copyright or whose legal copyright term has expired. Whether a book is in the public domain may vary country to country. Public domain books are our gateways to the past, representing a wealth of history, culture and knowledge that's often difficult to discover.

Marks, notations and other marginalia present in the original volume will appear in this file - a reminder of this book's long journey from the publisher to a library and finally to you.

Usage guidelines

Google is proud to partner with libraries to digitize public domain materials and make them widely accessible. Public domain books belong to the public and we are merely their custodians. Nevertheless, this work is expensive, so in order to keep providing this resource, we have taken steps to prevent abuse by commercial parties, including placing technical restrictions on automated querying.

We also ask that you:

- + *Make non-commercial use of the files* We designed Google Book Search for use by individuals, and we request that you use these files for personal, non-commercial purposes.
- + *Refrain from automated querying* Do not send automated queries of any sort to Google's system: If you are conducting research on machine translation, optical character recognition or other areas where access to a large amount of text is helpful, please contact us. We encourage the use of public domain materials for these purposes and may be able to help.
- + *Maintain attribution* The Google "watermark" you see on each file is essential for informing people about this project and helping them find additional materials through Google Book Search. Please do not remove it.
- + *Keep it legal* Whatever your use, remember that you are responsible for ensuring that what you are doing is legal. Do not assume that just because we believe a book is in the public domain for users in the United States, that the work is also in the public domain for users in other countries. Whether a book is still in copyright varies from country to country, and we can't offer guidance on whether any specific use of any specific book is allowed. Please do not assume that a book's appearance in Google Book Search means it can be used in any manner anywhere in the world. Copyright infringement liability can be quite severe.

About Google Book Search

Google's mission is to organize the world's information and to make it universally accessible and useful. Google Book Search helps readers discover the world's books while helping authors and publishers reach new audiences. You can search through the full text of this book on the web at <http://books.google.com/>

Eng 7229.06.3



HARVARD
COLLEGE
LIBRARY



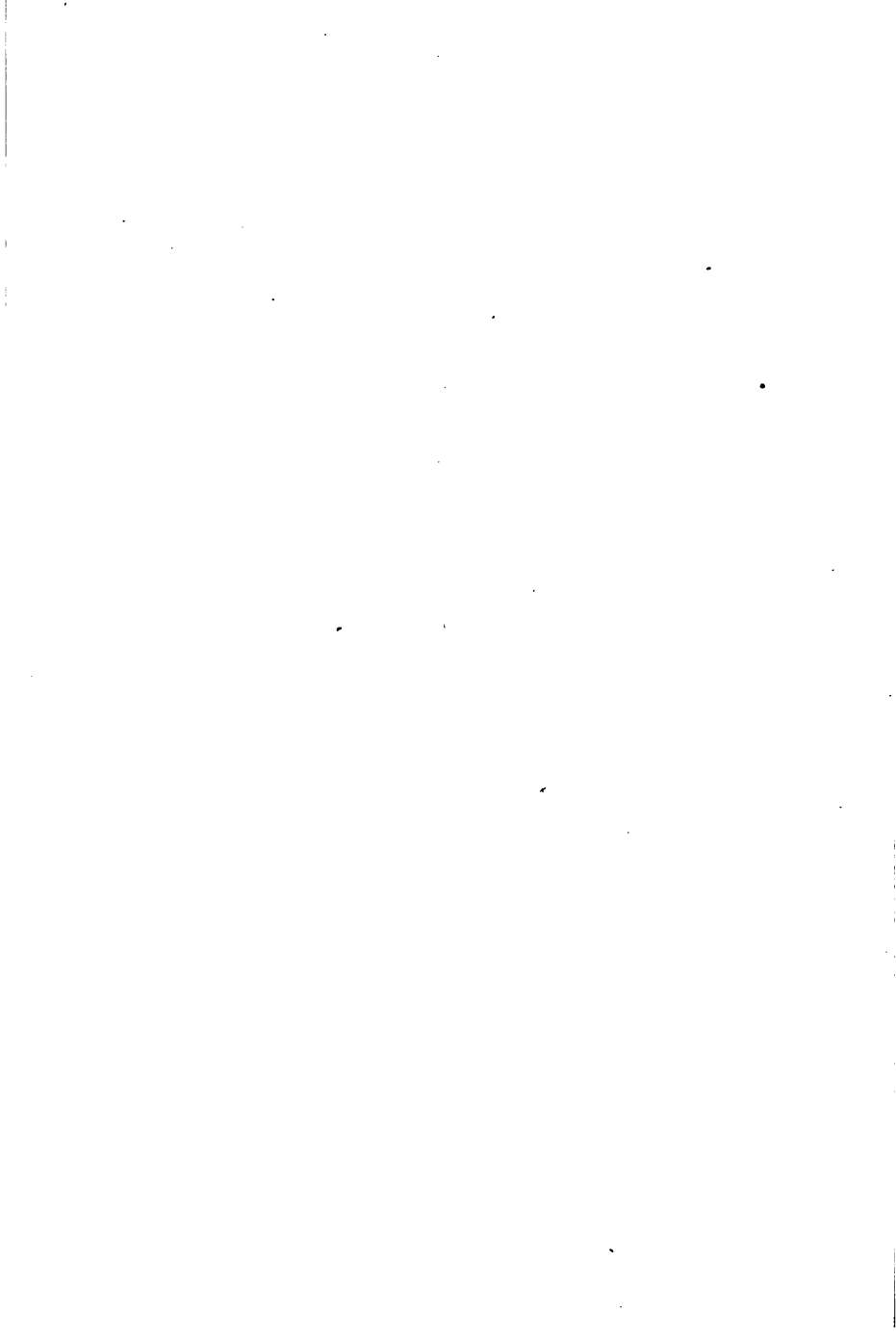

WIRELESS TELEGRAPHY

AN ELEMENTARY TREATISE

BY

A. E. KENNELLY, A. M., Sc. D.

Professor of Electrical Engineering in
Harvard University

WITH SIXTY-SIX ILLUSTRATIONS

NEW YORK
MOFFATT, YARD & COMPANY
1906

Eng. 4229.06.3

✓
HARVARD COLLEGE LIBRARY
TRANSFERRED FROM THE
ENGINEERING SCHOOL
1939

COPYRIGHT, 1906, BY
MOFFATT, YARD & COMPANY

Published November, 1906

PREFACE

WIRELESS TELEGRAPHY is a wonderful and fascinating subject. It has come to abide. It is ubiquitous in range, and there is no corner of the world, above the level of conductors, which is exempt from the play and passage of its ethereal waves. The laws obeyed by these waves, when stated without embellishment, vie with fiction in wonderment and interest. The possibilities which these waves hold in store for the benefit of man can at present only be guessed at, but they are probably great, judging from the importance of the work already done.

It has been the author's endeavor to present the elementary facts concerning the nature and operation of wireless telegraphy in language as free from technicality as possible, and without the use of algebra, so as to permit of the book being submitted to the consideration of persons not technically versed in electricity or its applications. At the same time, it is hoped that the treatment may not be unsuited to the needs of those readers who are familiar with other elec-

trical applications, but who have not made a special study of wireless telegraphy.

The author has selected the relations between wire and wireless telegraphy as the line of development of the subject. In the literature of the subject, this method of presentation has not received much attention. It is believed that a comparison of the conditions in wire and wireless telegraphy throws great light on both, and is, perhaps, the simplest mode of dealing with wireless telegraphy.

The author desires to acknowledge his indebtedness to the publications of the following writers: A. F. Collins, R. A. Fessenden, J. A. Fleming, J. E. Ives, D. Mazotto, G. W. Pierce, H. Poincarè, A. Righi, C. H. Sewall, and A. Slaby; also in particular, to Prof. R. A. Fessenden for many facts and suggestions.

Books on wireless telegraphy usually deal to a considerable extent with the systems and apparatus of individual inventors. It is submitted, however, that the question of priority of invention is entirely separate from the questions of condition and mode of operation considered in this little book. In order to deal properly with the subject from the standpoint of invention, it would be necessary to modify the order of description materially. Moreover, the growth and

PREFACE

v

development of wireless telegraphy are so recent, that special study is required to distinguish between the contributions to the science and to the art by the various workers in this interesting and important field of applied electromagnetics. The author has, therefore, taken the liberty of describing things and operations, without attempting to trace each to its appropriate inventor.

CAMBRIDGE, *November*, 1906.



CONTENTS

CHAPTER	PAGE
I INTRODUCTORY	1
II WAVES AND WAVE-MOTION	3
III MAGNETISM AND ELECTRICITY	14
IV ELECTROMAGNETIC WAVES GUIDED OVER CONDUCTORS	29
V ELECTROMAGNETIC WAVES GUIDED BY SINGLE WIRES	36
VI RADIATED ELECTROMAGNETIC WAVES GUIDED BY THE GROUND	40
VII UNGUIDED OR SPHERICALLY RADIATED ELECTROMAGNETIC WAVES	64
VIII PLANE ELECTROMAGNETIC WAVES	75
IX THE SIMPLE ANTENNA OR VERTICAL ROD OSCILLATOR	97
X ELECTROMAGNETIC WAVE-DETECTORS OR WIRELESS TELEGRAPH RECEIVERS	124
XI WIRELESS TELEGRAPH WORKING	149
XII TUNED OR SELECTIVE SIGNALING	173
XIII MEASUREMENTS OF ELECTROMAGNETIC WAVES	191
XIV INDUSTRIAL WIRELESS TELEGRAPHY	198

CHAPTER I

INTRODUCTORY

ELECTRICITY is *not* in its infancy, popular impression notwithstanding. Electric applications, such as the telephone, the wire telegraph, the electric lamp and the electric motor, are very familiar in modern life and have been for a number of years. Electricity has reached adolescence in these directions. But wireless telegraphy, the most recent of electric applications, is, perhaps, in its infancy. It is only about ten years old.

There is something fascinating about the way in which electricity works. It is as swift as it is stealthy. Electric impulses move over wires at enormous speeds and yet the action is invisible and inaudible, appealing to no sense directly. A telegraph wire runs overhead say from New York to Buffalo and the New York sending operator closes the circuit at his key. Almost instantly, and certainly within about one-tenth of a second, the little lever of the receiving instrument at Buffalo responds. The electric im-

pulse reaches its destination perhaps as rapidly as we can turn our thoughts from one end of the wire to the other.

We cannot see the electric impulse rush along the wire, we cannot hear it travel. We can only picture the transfer in our imagination. We can see the wire and we know it travels along that. If we cut the wire anywhere, the electric current is stopped.

When we turn to wireless telegraphy, however, we are deprived even of the consolation of a guiding wire to aid the imagination. The phenomenon of the wire telegraph is a mystery, but a familiar one to which the wire is a clue. The new phenomenon of the wireless telegraph is a yet more elusive mystery with no clue, at first sight. Nevertheless, we shall see in the sequel that there is not so much difference between the two cases as might at first be supposed. The relations between wireless telegraphy and wire telegraphy resemble the relations between sound distributed in the open air, and sound channeled, or confined, within a speaking tube.

CHAPTER II

WAVES AND WAVE-MOTION

SINCE wireless telegraphy is carried on by means of electro-magnetic waves, it is desirable to examine into the nature of those types of waves with which we are more familiar, before taking up the consideration of the less familiar electro-magnetic waves.

Free Ocean Waves

A wave is a progressive disturbance, or a disturbance which moves along through some kind of medium. The most familiar type of wave is the disturbance in the level of water by some displacing force, such as wind, or the splash of a falling body. Even in calm weather, we usually find a wave-motion, commonly called *swell*, on the surface of the ocean. We then find displacements of the ocean level, alternately up and down, or high and low, moving along the surface. These waves have a certain direction, say from west to east, in the horizontal plane or plane of ocean level. They also have a cer-

tain speed in this direction. On the deep ocean this speed may be, say, 12 meters per second (39.4 feet per second, or 26.8 miles per hour). Of course this does not mean that in calm weather a cork, or lifeboat, floating on the sea, is moved along by the swell at this high speed. The cork, or the boat, bobs up and down on the swell, with only a very small movement in the swell's direction. But it means that a torpedo boat would have to steam in this case at a speed of 26.8 miles per hour from west to east in order to keep abreast of any one particular roller in the swell. It is to be observed that the waves advance through and over the water, without carrying the water bodily along to any marked extent.

Another noteworthy point in the waves of ocean swell is that there is commonly a fairly definite and uniform wave-length. This wave-length is measured in the direction of wave-motion, and may be taken as the distance from crest to crest of successive waves. This wave-length in open ocean swell is often about 100 meters (328 feet or 109.3 yards). A tightly stretched string 328 feet long, held east and west, would in such a case just span the depression between successive roller crests.

The waves of the ocean manifestly contain *energy*. That is to say, work had to be done

originally by the winds to produce them, and the waves are capable of doing a good deal of work before being brought to rest. Attempts have been made, in fact, to obtain work from waves at suitable points on the sea-coast by means of engines operated by the rise and fall of the waves.

Sound-Waves in Air

A type of wave of which we are constantly receiving impressions through our ears, but which is more difficult to analyze than the ocean wave, is the sound-wave in the atmosphere. Waves of sound are invisible and hence the difficulty we experience in becoming familiar with their forms, speed and other properties. We learn that sound in air is a disturbance in its density and pressure which moves through the air at a definite speed. If we fire a pistol in the air, the explosion in the barrel displaces the air, or compresses it, in the immediate neighborhood of the discharge. The zone of compression moves off into surrounding air with substantially the same speed in all directions, if the air is calm, and is followed immediately by a zone of expanded air; just as a hollow or depression follows a hump or elevation in an ocean wave.

Fig. 1 gives a diagrammatic view of a single sound-wave of compression and dilation, shortly after the wave has moved off from the explosion



FIG. 1.—Diagram Indicating a Single Sound Wave Shortly after Leaving Its Source.

or origin of the disturbance, o . The wave is hemispherical in form, and the diameter of the hemisphere is $a a$, at the instant considered. The external portion of the hemispherical wave shell contains compressed air, indicated by the concentric semi-circles. The internal dotted portion, immediately following, contains expanded air. After a brief interval of time the wave will have expanded to the contour indicated in Fig. 2, where the diameter of the hemis-

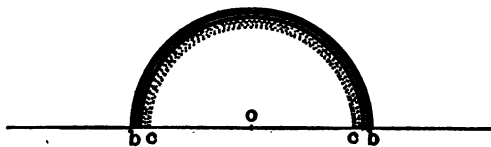

FIG. 2.—Diagram Indicating a Single Sound Wave Which Has Separated Itself from Its Origin by Five Wave-Lengths.

pherical shell is $b o b$. The length of the wave is the distance $b c$, measured radially from the front to the back of the wave, or from the out-

side to the inside of the hemispherical shell. If this wave-length be, say 100 meters (328 feet or 109.3 yards), then the distance $o c$, by which the wave has already removed itself from the origin, is 500 meters (1640 feet or 546.7 yards). Another brief interval of time would bring about the condition indicated in Fig. 3, where the wave

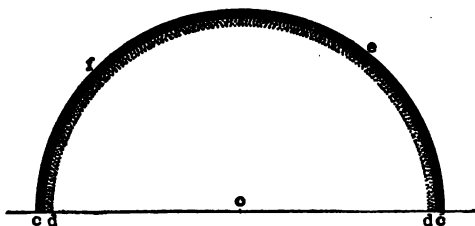

FIG. 3.—Diagram Indicating a Single Sound-Wave Which Has Separated Itself from Its Origin by Eleven Wave-Lengths.

has expanded hemispherically to the diameter $c o c$. The length of the wave, $c d$ remains as it was in the earlier stages, assumed as 100 meters (328 feet or 109.3 yards); but the distance $o d$ which the wave has now placed between itself and the origin is 1100 meters (3609 feet or 1203 yards). Observers in balloons floating in the air at points such as e or f on the wave front, would hear the sound of the explosion simultaneously with observers on the ground at points $c c$.

PHOTOGRAPHY

Light and Color

The study of light and color is essential to the understanding of photography. Light is the energy that makes vision possible, and color is the result of the way our eyes and brains interpret the wavelengths of light. In photography, light is captured on a light-sensitive surface, such as a film or a digital sensor, to create a permanent record of a scene. The properties of light, such as its wavelength, frequency, and intensity, determine the colors and brightness of the image. Understanding the science of light and color allows photographers to control the appearance of their images and to create the desired artistic effect.

The study of light and color is essential to the understanding of photography. Light is the energy that makes vision possible, and color is the result of the way our eyes and brains interpret the wavelengths of light. In photography, light is captured on a light-sensitive surface, such as a film or a digital sensor, to create a permanent record of a scene. The properties of light, such as its wavelength, frequency, and intensity, determine the colors and brightness of the image. Understanding the science of light and color allows photographers to control the appearance of their images and to create the desired artistic effect.

occupied by the wave in the stage of Fig. 2 with radius $o a$, 150 meters (164 yards), would be 13.6 millions of cubic meters; in the stage of Fig. 2, 382 millions of cubic meters, and in the stage of Fig. 3, 1660 millions of cubic meters (corresponding to 17.8, 500, and 2160 millions of cubic yards respectively). It is evident, therefore, that the energy in the wave is constantly spread out into more space, or diluted, as the wave expands; so that the energy in a given volume, such as 1 cubic meter, is constantly diminishing. This is another way of saying that the *intensity* of the wave diminishes as time goes on, and the radius of the wave increases. The loudness of the explosion as noted by an observer at a in Fig. 1 would be considerably greater than that noted by an observer at b in Fig. 2; or again, than that noted by an observer at c in Fig. 3.

If we were to place a sufficiently sensitive recording barometer anywhere in the neighborhood of the explosion, and carefully observe the barometer record as the noise of the explosion occurred, we should expect to find that the barometer would record, just before the explosion, a horizontal straight line $a b$, Fig. 4, corresponding to the reading of the barometer at that time, say 760 millimeters (29.92 inches) of mercury. When the sound of the explosion arrived, the

barometer would rise very slightly to $b c$, then fall to e , and then return to the normal straight line $f g$. The elevation from b to c would mark the degree of compression in the first half of the wave, and the depression from d to e would similarly mark the following dilatation. The crest height $k c$, or $k_1 e$, would measure the *amplitude* of the disturbance or amplitude of the wave. If the barometer were located close to

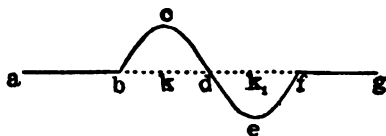

FIG. 4.—Ideal Barometric Record at the Time of Passage of the Noise of an Explosion.

the origin of the explosion, as at a in Fig. 1, the amplitude of the pressure disturbance record, and the amplitude of the recorded sound, would be relatively large. If, on the other hand, the barometer were placed further from the origin, as at c in Fig. 3, the amplitude both of the recorded disturbance and of the sound-wave at the barometer would be smaller.

Ordinary sound-waves possess so little energy, or have so small an amplitude, that recording barometers show no trace of them. Expressing the same thing in another way, the impression-

producing mechanism of the ear is far more sensitive to the disturbances of pressure in sound-waves than the ordinary barometer.

Very powerful explosions are capable of producing sound-waves of sufficient intensity to be observed at great distances. The great explosion of the volcano Krakatoa, near the Sunda Straits, in the year 1883, is stated to have been heard at distances greater than 3200 kilometers (2000 miles). The outgoing wave affected barometers all over the world, and left traces on recording barometers. This wave is stated to have traveled at a speed of 1130 kilometers per hour (700 miles per hour), to have swelled at the antipodes to Krakatoa, in 18 hours, and to have spread out again over the globe. It was not finally lost sight of until it had passed around the globe several times. When the first outgoing wave passed over Singapore, a port distant about 830 kilometers (516 miles) from the origin of the disturbance, the gas-holder of the town is stated to have leaped into the air several feet up and down.

Sound-Wave Trains

If instead of producing a solitary explosion at the origin, and a corresponding solitary wave moving off radially therefrom, we produce a

rapidly and rhythmically repeated disturbance; as in blowing air through an organ-pipe, or forcing air through a syren-wheel, a succession of waves is produced, and the sensory effect produced on the ear is that of a tone or musi-

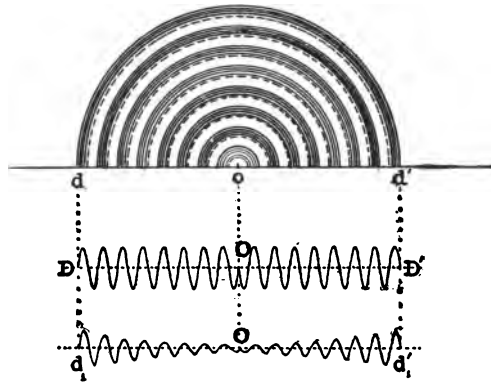

FIG. 5.—Diagram Representing the Succession of Sound-Waves Emitted from the Origin *O* When a Simple Musical Note Is There Produced.

cal note. A succession of outgoing waves is diagrammatically represented in Fig. 5. The shaded areas there correspond to zones of compressed air, and the intermediate unshaded areas to zones of dilated air. Eight complete waves are indicated. If the note sounded be the deepest E of the double-bass viol, making 40 complete vibrations a second, then the length

of each wave will be the fortieth part of 333 meters, the distance which sound travels in a second, because 40 complete waves will occupy the space covered by advancing sound in one second. Each wave will, therefore, be 8.33 meters (27.34 feet or 9.11 yards) in length, and the length $o d$ of eight wave-lengths will have been covered in one-fifth of a second from the commencement of the sound.

The curve at $D O$ or $O D'$ gives the trace-record that we should expect a recording barometer would give at d after all of the eight waves passed by, on the supposition that this pure, musical note was sustained uniformly for eight complete cycles of the disturbance. If, however, the string of the double-bass, instead of being excited by the bow, were plucked by the finger in such a manner that the vibrations died away, then the record of the supposed sensitive barometer at d might indicate the curve $d_1 o$ of decaying amplitudes.

CHAPTER III

MAGNETISM AND ELECTRICITY

HAVING paved the way for a consideration of electromagnetic waves by a few outlines of sound waves in air, we may now fitly turn attention to magnetism and electricity.

Wind and Its Energy

Everyone is familiar with the fact that wind is an active or disturbed state of the atmosphere, a movement of the air. We ordinarily understand wind to be a uniform movement of the air in any one given direction, and we ordinarily understand by *eddies* or *gusts*, twisting or vortical movements of the air, but, in general, wind may include both linear movement and vortical movement, since one cannot occur in the atmosphere without involving the other. The material for the creation of a wind is always present, for this material is the air itself. We only need to energise the air in a particular way, to make it move forward. Energy must be expended in producing a wind, and energy resides in the wind.

If we employ a hand-fan to produce a local breeze, we must expend muscular energy, or do work on the fan, to force the air into motion, and the air once set in motion contains energy or can do work by moving, for example, light obstacles in its path. Consequently, we may say that wind is air, plus energy given to it in a particular way.

Air is a material fluid. It forms an ocean on the surface of this earth, and we live at or near the bottom of this air-ocean. Air gravitates, or pulls upon the mass of the earth. Each individual atom of air gravitates, and the sum total of all the individual pulls exerted on the earth amounts to a pressure of about 1 kilogramme per square centimeter of surface (14.25 lbs. per sq. inch).

The Invisible Ether

It is generally believed that all space, including the interior of solid bodies, is permeated by an immaterial fluid called the universal ether. The ether is just as invisible as air. Whether it consist of matter or not, it is immaterial in the sense that it apparently does not gravitate. It does not directly appeal to any sense, but it is much easier to assume its presence everywhere than to deny its existence. If we take a vacuum-

tube, *i.e.*, a sealed glass tube from the interior of which the air has been almost entirely removed, it can be shown experimentally that sound cannot move across the interior of the tube, but light passes across it, and so do radiant heat and gravitational force. We cannot believe that these activities are transmitted through absolutely empty space. Something must transmit them, for they are transmitted at definite speeds. This something is named the ether. Beyond its powers of transmitting energy, hardly anything is yet known about the ether. Its structure, and the manner in which it permeates space, are still unsolved riddles.

Nature of Electricity and Magnetism

As soon as the ether is postulated to be a universal fluid or medium in which all matter swims, so to speak, many things may be accounted for which otherwise we could not even attempt to explain. Electricity and magnetism, for example, may be accounted for in a general way. Just as wind is, we have seen, a particular energized condition of the circumambient air, so both electricity and magnetism are particular energized conditions of the universal ether, which underlies the air and everything else. It is not so easy, however, to define the nature and rela-

tions of these particular energized conditions. We cannot at present say, for example, that electricity is the same kind of motion of the ether that wind is of the air. If we do not yet apprehend the nature of the ether itself, how shall the task be undertaken of defining its energized conditions? The energized conditions might be statical, and involve no motion of ether, like the energy of a stationary coiled-up spring; or they might be dynamical, and involve modes of motion of the ether. In any event, it seems clear from the known laws of electromagnetism that there is a definite mutual relation between the two energized conditions of ether, electricity and magnetism, such that as soon as either is defined the other also is immediately determined. In mathematical language, one is the "curl" of the other. If, for instance, electricity should be a definite kind of tension or static stress longwise, then magnetism would be a definite kind of twist or crosswise static stress, and reciprocally. Or, if electricity should be a simple, straightforward motion, or streaming, of the ether, then magnetism would be eddy motion or vortical rotational motion, or spin, of the ether, and reciprocally. It is surprising how much is known concerning the laws of action and behavior of electricity and magnetism, considering the little

that is known of their absolute fundamental nature. We can control electricity and magnetism remarkably well, considering that we do so from beyond a hitherto impenetrable veil that does not admit of perceiving the things directed.

It is evident that whatever may be the precise nature of electricity and magnetism, the widely admitted postulate of the universal ether requires that the material for either or both is omnipresent. Just as the material for wind is always present in the circumambient air, and all we need is the application of energy to the air in a particular way in order to produce a wind, so the material for electricity or magnetism is universally present, and all we need is the application of energy to the ether in particular ways. Consequently, electricity and magnetism may be regarded as the ether, plus particular forms of energy.

Magnetic Flux and Its Properties

If we consider an ordinary, permanent horse-shoe magnet, such as is indicated in Fig. 6, we find that all around it, and particularly between its poles N and S, there is a certain invisible activity which possesses both direction and intensity. In the illustration, the direction is roughly indicated by the broken lines with arrow-heads, and the intensity by the relative crowding or con-

densation of these lines. The direction of this magnetic activity in the air between the poles is seen to be from the north pole N to the south pole S. This is strictly speaking a pure convention. It might have been originally agreed to draw all the arrows in the opposite direction.

All that is certain is that there is a definite polarity about the system, and that the actions pertaining to the north pole are distinctly inverse to the actions pertaining to the south pole, magneticians all agreeing upon the direction shown.

The north pole is the pole which, if the magnet were freely suspended, would seek for,

or point approximately toward, the north geographic pole of the earth, or the earth's magnetic pole near the Greenland end of the earth's axis.

That is, the N end is the north-seeking end.

As roughly indicated in Fig. 6, the magnetic activity, or *magnetic flux* as it is called, is densest or most intense, in the air between the opposing

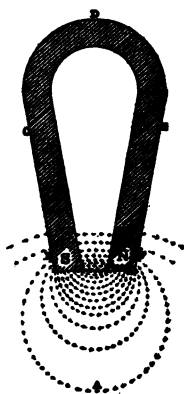

FIG. 6.—Diagram of Magnetic Flux in the Space Between the Poles of a Permanent Magnet.

or point approximately toward, the north geographic pole of the earth, or the earth's magnetic pole near the Greenland end of the earth's axis. That is, the N end is the north-seeking end.

As roughly indicated in Fig. 6, the magnetic activity, or *magnetic flux* as it is called, is densest or most intense, in the air between the opposing

pole-tips, or where the air-space separating the poles is shortest. As we leave this region, the magnetic flux becomes thinner, or weaker. A peculiarity about this flux is that it always returns back upon itself in closed loops or chains. In other words, magnetic flux is always continuous and re-entrant. At first sight it appears to be discontinuous, because it seems to commence at one pole and end at the other. But it can be shown experimentally that the flux continues through the interior substance of the steel magnet, and each loop, such as N A S, completes a circuit B C D E F within the substance of the magnet.

Provisional Hypothesis as to Nature of Magnetic Flux

Although the real nature of this magnetic flux is not yet known, yet it may help us to follow the actions of electromagnetic waves later on, if we assume, for the purposes of description, that magnetic flux is a streaming motion of the ether. On this assumption, a permanent magnet is a force pump which draws the ether in at the south pole, through the substance of the steel in the interior, and forces it out at the north pole. With no friction, this streaming would not necessarily absorb energy, and we know that perma-

nent magnets may be designed to retain their magnetism without sensible diminution for an indefinitely long time.

Energy of Magnetic Flux

Although magnetic flux does not need energy to be expended in order to keep it going, yet energy has to be expended to create it. That is, magnetic flux contains energy, or has energy always associated with it. As long as the magnetic flux persists, the energy resides quiescent with it. When the flux disappears, its energy disappears also. Consequently work must be done to create magnetic flux, and magnetic flux is able to do work or give up its energy when it disappears.

Between the opposed pole-tips N S, we may consider, on the above hypothesis, that the stream of ether is densest, and receding from this region the stream gets weaker. The streaming is steady both at any particular point for all considered time, and for all points at any one time. The magnet ether-pump is steady. The pumping action is due to activities in the molecules of the steel. Each molecule of iron is supposed to be a little individual ether pump, by virtue of internal activities as yet only dimly guessed at. When the horseshoe is magnetized, all of the mo-

lecules are caused to align themselves in parallel directions, or to face the same way, whereby they all pump the ether in the same general direction. Within the iron molecules, the pumping activities are believed to be electric; but into these we need not enter. The point here to be observed is that in the air-space outside of the magnet, the steady magnetic flux produces no electric action. In this air-space we find magnetism but not electricity. If, however, we move the magnet, and with the magnet the system of magnetic flux pertaining thereto, there will be electric action produced where the magnetic flux lines are carried through space. If, for example, the magnet be lifted bodily toward the observer without twisting, feeble electric forces will be brought into play in directions lying within the plane of the horseshoe. In the region between the poles these electric forces will be directed, during the motion, in the direction from A to D. The intensity of these electric forces will be proportional to the speed with which the magnetic flux moves sidewise. If the magnetic flux moves longwise, or parallel to itself, there is no electric action set up, but if the magnetic flux moves sidewise, or crabwise, there is electric action set up. It is on this action that all dynamos depend; namely, upon relative sideways

motion between magnetic flux and an electric conductor to pick up and utilize the induced electric force. Steady and stationary magnetic flux is thus unaccompanied by electric action, but unsteady, varying, or sidewise-moving magnetic flux sets up electric action.

Electric Flux and Its Properties

Turning now to electricity, Fig. 7 represents a vertical metallic rod, and terminal balls, sup-

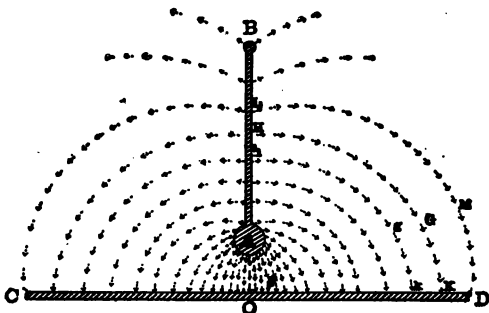

FIG. 7.—Diagram of Electric Flux in the Space Between an Electrified Rod and Disk.

ported by an insulating holder not shown, in air above the center O, of a horizontal, insulated metallic disk C O D. This insulated pair of conductors may be electrically charged either by a frictional electric machine, an influence machine, a spark coil, or a voltaic battery. That

is, the charge may be communicated from any suitable electric source. The charge will be retained, because the rod is insulated from the disk, and if the insulation could be made perfect, the charge would be retained indefinitely. Let us suppose that the rod is positively charged and the disk negatively.

In the air-space between the electrified rod and disk there is an invisible influence which possesses both direction and intensity. It is called electric flux. This electric flux is diagrammatically represented in Fig. 7 by the little arrows which proceed, by convention, from the positive charge to the negative charge. The arrows are drawn on little lines of points, instead of little broken lines as in Fig. 6, in order to distinguish them from lines of magnetic flux. Between A and O, where the air-space is shortest, the electric flux is most densely crowded, or its intensity is greatest. As the separating air-space increases, the flux density weakens.

Energy of Electric Flux

Energy always resides in the electric flux, so that each and every part of the region permeated by the electric flux represented in the illustration contains energy. The energy is not uniformly distributed. It is greater per unit volume at a

point like F than at a point like G. It is stowed away in proportion to the square of the electric flux density, so that in two regions one of which has double the flux density of the other, there will be four times more energy per cubic centimeter, or cubic inch of space, in the former than in the latter. As long as the electric flux persists, this energy resides therein or accompanies it, and when the flux disappears the energy has disappeared. This energy is communicated to the ether in the insulating air between rod and disk at the time of their charge.

*Provisional Hypothesis as to the Nature of
Electric Flux*

In conformity with the provisional hypothesis already adopted for magnetic flux, stationary electric flux may be assumed to be an elastic twist or stress in the ether; so that the whole system of ether tends to revolve clockwise about the rod A B as axis, when looking down on the disk from above. The screw or twist will have maximum intensity along the central line O A, and is resisted by the elastic rigidity of the ether. The elastic energy of the twist is the total energy of the electric flux as summed up throughout the entire *electric field*, or permeated insulating

region. The amount of electric energy that air can be made to hold without breaking electrically, or disrupting into a spark discharge, depends upon the atmospheric pressure and upon the shape of the opposed electrified surfaces. At ordinary atmospheric pressures, and parallel opposed surfaces, the most favorable form, the energy that air can hold is limited to about 480 ergs per *c. c.*, or 1 foot-pound per cubic foot; *i.e.*, the work done by lifting one pound one foot high, to the cubic foot of air space under powerful electric stress.

Electric flux at rest differs from magnetic flux at rest in the fact that the former is discontinuous while the latter is continuous. The magnetic flux, as we have seen, always forms closed loops or chains in space. Steady electric flux, on the contrary, always starts from a positive charge and ends on a negative charge. In the case of opposed conductors, the charges always reside on their surfaces, and thus the electric flux always starts on the surface of the positive conductor and ends on the surface of the negative conductor.

Tensions in Electric and Magnetic Fluxes

The electric flux, like magnetic flux, always possesses the property of pulling along its own

direction at the same time that it pushes sideways. The curved arrow lines of Fig. 7 merely indicate the direction and the relative crowding of the electric flux from point to point of this particular electrified system; but if we suppose that each of these lines is a little elastic thread, exerting a certain mechanical tension, and if we also suppose that each such elastic thread exerts a repulsion sideways against its neighbors, or tries to secure all the elbow-room it can, we get an idea of the static forces which reside in such a stationary electric flux. Thus, the line $H G K$, in addition to its own tension, pushes sideways against the adjacent lines $h g k$ and $L M D$. The resultant effect is a tension, or attractive pull, between the rod and the disk, or the familiar attractive force between oppositely electrified bodies.

As long as the electric flux remains steady and stationary, no magnetism, or magnetic force is produced. There will be a tendency to move any electrified object, such as a pith-ball, along the electric flux in Fig. 7, but there will be no tendency to affect the direction of a magnetic compass-needle. If, however, the electrified system be moved bodily sidewise, without losing the charge, feeble magnetic forces will be developed in directions at right angles both to the

moving electric flux and to the direction of motion.

Just as sidewise-moving magnetic flux generates electric flux, so sidewise-moving electric flux generates magnetic flux.

CHAPTER IV

ELECTROMAGNETIC WAVES GUIDED OVER CONDUCTORS

Automatic Movement of Electric Flux over Conducting Surfaces

IN order to bring electric flux into movement, it is not necessary to move a charged system of conductors, the flux will set itself in motion if an opportunity is offered to let it slide upon a pair of conductors.

Electric Current Over a Pair of Wires

If we bring a long pair of parallel insulated metallic wires M N, P Q, Fig. 8, simultaneously into contact, one with the rod and the other with the disk, as indicated in the figure, the electric flux immediately takes advantage of the extension of the system thus offered and glides away, guided by the wires. It may be considered that the sidewise repulsion of the flux tends to make it spread its boundaries in this way, whenever possible. The electric charge moves out along the wires hand in hand with the electric flux, the positive charge spreading along the upper wire

M N, in Fig. 8, and the negative charge along the lower wire P Q. The electric flux runs along with these charges, always bridging over between the positive and negative charges. The phenomenon of the movement of two parallel moving

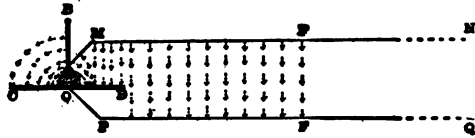

FIG. 8.—Electric Flux Wave Moving Over Pair of Parallel Insulated Wires.

charges with the moving electric flux between them and linking them, constitutes an *electric current*, or electric discharge.

The effect of bringing the two parallel wires into contact with the charged electric system of Fig. 7, is, therefore, to let the charge escape over the wires, and to set up thereby an electric current over the wires. The current rush takes place in the form of a wave. Electric flux and its associated energy move off the disk into the insulating air-space between the wires.

Creation of Magnetic Flux by Moving Electric Flux

We have already seen that sideways-moving electric flux generates magnetic force and flux.

As soon, therefore, as the electric flux begins to move, half of the electric flux energy disappears and is replaced in the form of magnetic energy. Instead of having stationary electric flux in the confined insulated system of Fig. 7, we have moving electric flux, and magnetic flux associated therewith, or advancing with it. Consequently, although we can have either stationary electric flux alone, or stationary magnetic flux alone, we cannot preserve them independently when they move freely in an insulator. Any wave of electric disturbance is an *electromagnetic wave*, because in it electric and magnetic fluxes are tied up together.

Electromagnetic Wave Guided by a Pair of Parallel Wires

The distributions of the electric and magnetic fluxes in the advancing wave of Fig. 7 are illustrated in Fig. 9, where M P are the sections of the two parallel wires in a plane at right angles to their length. The electric flux-paths are indicated, as in previous instances, by lines of points with arrow heads; while the magnetic flux-paths are indicated by broken lines with arrow heads. The wave is supposed to be receding from the observer, and the upper wire M is carrying the positive charge, while P, the lower wire, carries

the negative charge. The electric flux, therefore, emerges from the surface of the wire M and terminates upon the surface of the wire P. If the metal of which the wires are composed be supposed to conduct perfectly, the electric flux

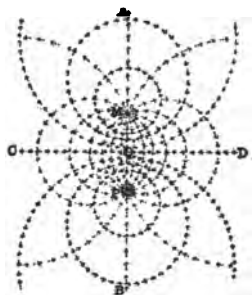

FIG. 9.—Electric and Magnetic Fluxes in Electromagnetic Wave Guided by Two Parallel Wires. Wave Receding from Observer.

will skim over the surfaces of the wires and not penetrate into their mass. The more imperfect the conductivity of the wires, the more deeply the moving electric flux will penetrate into them.

The magnetic flux at the center O of the loop has the direction D O C, perpendicular to the loop. At all other points

the magnetic flux-paths are circular in this plane of cross-section, or cylindrical with regard to a length of the wires. Both the electric and the magnetic flux-paths are systems of circles, and it is to be noticed that at every point they intersect each other perpendicularly. That is, any one circle crosses all the intersecting circles at right angles.

It is also to be observed that where the electric

flux runs densest, so does the magnetic flux. The densest electric and magnetic fluxes are found close to either wire. Both the fluxes get weaker as we recede from the wires. In fact the intensity of the electric flux in any single pure electromagnetic wave is always and everywhere numerically equal to the intensity of the magnetic flux at the same point and time, when each is measured in its appropriate units. At an indefinitely great distance from the loop of active wires the density of the fluxes is nil.

Speed of Electromagnetic Waves

The speed of sound waves in air we have seen to be in the neighborhood of 333 meters per second, (1090 feet per second or 746 miles per hour). But the speed of a free electric wave in air is enormously greater, being approximately 300,000 kilometers per second (186,400 miles per second), or $7\frac{1}{2}$ times around the world in a second. This is also the speed at which light travels in air. That is to say, no difference has yet been determined between the speed of electromagnetic waves in air and the speed of light.

Energy is carried in the advancing electromagnetic wave indicated in Figs. 8 and 9. The energy is the energy residing in all the electric flux that moves on, plus the equal amount of

energy in all the associated and interlinked magnetic flux. This energy is carried away from the original stock of electric energy in the air-space of the electrified system in Figs. 6 and 7. The energy was originally bound up in the stationary electric flux. The advancing electric and magnetic fluxes in the wave robbed the charged system of flux and of energy and transported that energy whithersoever they went.

Summing up the conditions which we have noted in the guided electromagnetic wave of Figs. 8 and 9 we may state them as follows:—

An electric or magnetic disturbance associated with a pair of insulated aerial wires propagates itself along the wires at the speed of light. The wave consists of electric and magnetic fluxes, which are always perpendicular to each other and to the direction in which the wave is moving. If the two wires are parallel, the fluxes are distributed cylindrically; *i.e.*, circularly in any plane perpendicular to the wires. The energy in each flux is the same, and the intensity of the two fluxes is the same at every point. The energy per unit volume varies as the square of the intensity of the moving fluxes. The advancing wave conveys this energy with it. On the surfaces of the wires are opposite electric charges, moving with the flux, and supporting the ends of

the electric flux. The entire series of associated phenomena is an electric current.

Guided electromagnetic waves properly belong to the domain of ordinary wire telegraphy, or to the transmission of electric power by wires. As such, they lie outside of the province of this enquiry. It may suffice to observe that the steady electric current found in any electric circuit operated by a dynamo, or a voltaic battery, is merely the sum of what is usually a large number of superimposed electromagnetic waves of the type above considered. These waves are kept streaming out of the dynamo, and are also reflected back from the distant end, or other parts, of the circuit; so that after a brief interval of time we have a complex aggregate of waves present. We may now proceed to the study of semi-guided electromagnetic waves, or waves in which the electric flux is held at one end only on an insulated artificial conductor, or is guided by but a single wire.

CHAPTER V.

ELECTROMAGNETIC WAVES GUIDED BY SINGLE WIRES

Electromagnetic Wave Guided by a Single Wire and the Ground

IF we place the disk C O D of Fig. 7 upon the level surface of the ground, taking pains to secure good electrical conductivity in the adjacent soil, and charge the vertical rod A B, while supporting the same insulated above the center O, there will be but little change effected in the charge or distribution of the electric flux by reason of the grounding of the disk. From an electrical point of view, we shall merely have indefinitely extended the area of the conducting disk. If we now bring a single very long insulated horizontal wire M N, like an ordinary telegraph wire into contact with the charged rod, as indicated in Fig. 10, the electric charge and electric flux will immediately rush out at light-speed over this wire in an electromagnetic wave. The electric flux will be guided by the wire M N on its

positive ends; but the negative ends will be unconstrained, or left loose to themselves. In this sense, the wave is only singly guided. If the surface of the earth $G G$ be assumed to conduct perfectly, the electric flux will skim over this surface, and a negative charge will also distribute

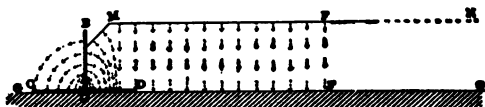

FIG. 10.—Single-Wire Guided Electromagnetic Wave.

itself over the same, advancing with the electric flux.

The electric flux under these circumstances will spread out over the surface of the ground $G G$ in such a distribution as would be effected if the ground were removed and in its place a second wire were run parallel to $M N$ and as far beneath the level surface $G F G$ as the first wire $M N$ is above it. The distribution is indicated in Fig. 11, where M is the section of the wire in a plane at right angles to its length, and $G G$ is the conducting surface of the ground. The wave in this case is supposed to be advancing towards the observer. The lines of points show the paths of electric flux issuing from the positive charge moving along the wire M . They terminate at a

negative charge distributed over $G G$, and moving over the same with like rapidity. N is the position of the "image" wire, which, in the absence of the ground $G G$, would be able, as in Fig. 9, to produce the same distribution of fluxes above the level $G O G$, as is developed with the

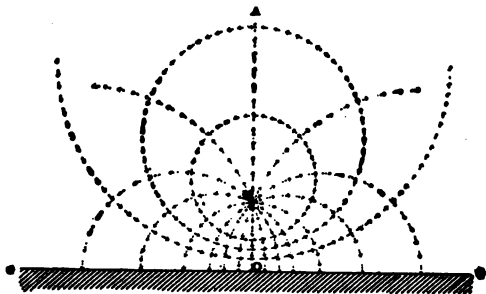

FIG. 11.—Electric and Magnetic Fluxes in Electromagnetic Wave Guided by a Single Wire Over a Conducting Ground Surface. Wave Advancing Toward Observer.

conducting ground. If the ground conducted perfectly, the electric flux would not penetrate below the surface; but would slide frictionless over the same. In practice, the conductivity of the ground is never perfect and the fluxes penetrate beneath the surface to a greater or less extent, with a corresponding expenditure of energy in the soil. Nevertheless, the conditions are

ordinarily regarded as a slight deviation from the condition of perfect earth conduction as indicated in the Figure.

The magnetic flux is established in cylindrical distribution, as shown, by the motion of the electric flux at the light-speed. The two fluxes have equal densities and energies at any given point, and between them they transport to a distance, along the wire, the energy originally bound up in the stationary electric flux of the charged system of Fig. 7.

The process thus initiated pertains to single-wire telegraphy, the usual type of wire telegraphy. The currents employed in telegraphy consist of such electromagnetic waves, either singly, or in superposition by confluence.

CHAPTER VI

RADIATED ELECTROMAGNETIC WAVES GUIDED BY THE GROUND

Radiation of Electromagnetic Waves by an Electric Disturbance or Explosion

THE electromagnetic waves considered in the last two chapters were set in motion by bringing a wire, or a pair of wires, into electric connection with the charged electric system, and allowing the electric flux to overflow from that system on to and along the wires. But electromagnetic waves may also be set in motion by sudden disturbances of an electric charge. In such cases the emitted waves are likely to be radiated in all directions in a manner resembling the expansion of a sound wave in air as outlined in Chapter II.

Let us suppose the rod and disk system to be charged, as indicated in Fig. 7, after the disk has been placed horizontally upon the surface of good conducting ground. Instead of allowing a wire to approach the rod and discharge it, let the system be discharged by a spark between A and O (Fig. 7). Let us assume that the discharge is

completed by a single spark of extremely short duration; so that the entire system of electric flux collapses precipitately. The flux near the axis A O is the first to disappear into the spark, then the longer and outlying flux. Last of all, the longest and furthest reaching flux issuing from B, will run down the rod and vanish at the gap A O.

If the discharge be delayed, or the charge allowed to dribble slowly across the gap A O, as, for example, by the action of rough and oxydised opposing surfaces, the collapse of the entire umbrella-shaped electric flux system of Fig. 7 may take place without any appreciable electromagnetic disturbance. The energy stored away in the flux will be expended in heating the path of discharge, and, when the process is complete, the flux having disappeared, the discharge stops, and there is no aftermath.

If, however, the collapse of the umbrella flux system in Fig. 7 is sudden, the rapid descent of the flux down the rod and into the gap A O sets up magnetic forces and magnetic flux. We have already seen that when electric flux moves, it establishes magnetic flux in a direction across itself, and also across the direction of motion; also that energy is imparted to the magnetic flux at the expense of the electric flux energy. If we

consider, for example, the particular flux path L M D in Fig. 7, it is evident that during the brief interval of collapse it tends to run at light-speed into the successive positions H G K, h g k, and so on to A O, when it disappears into the spark discharge. But the movement of this flux element will set up magnetic flux directed in planes parallel to the disk, and pointing towards the observer. On the other side of the rod A B, the similar inrush of electric flux will beget a magnetic flux in horizontal planes, *i.e.*, planes parallel to the disk, but directed away from the observer. Considering all the actions that occur simultaneously, it will be evident that a concentric ring system of magnetic flux will be set up, as in Fig. 12, around the rod A B as axis, each ring being in a horizontal plane. Part of the energy of the original electric flux of Fig. 7 is delivered to this ring distribution of magnetic flux; so that when the discharge is sudden, a lesser total energy tumbles into the spark than when the discharge is slow.

Fig. 12 indicates, in plan view, the ring distribution of magnetic flux accompanying the collapse of the umbrella electric distribution of Fig. 7, on the passage of a spark at O A. The eye of the observer is supposed to be situated immediately over the disk C D and rod B. The

magnetic flux streams are all directed clockwise, and they lie in various horizontal planes.

According to our provisional theory, we found in Chapter III, at page 25, that the original charge of the rod-and-disk system of Fig. 7 gave

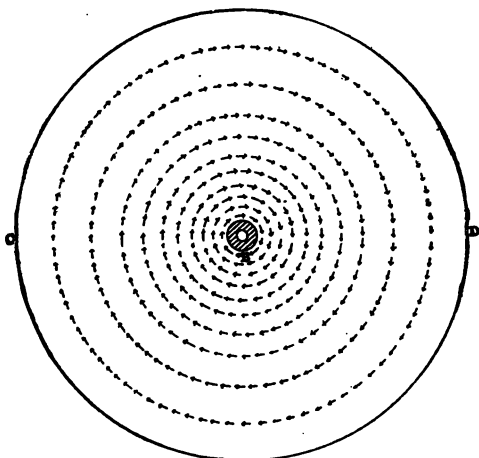

FIG. 12.—Plan View Diagram of Magnetic Flux Distribution Accompanying Collapse of Electric Flux Around Charged Rod.

a right-handed or clockwise screw-twist to the surrounding ether, as viewed by an observer looking down on the disk. The ether may be supposed to have taken a right-handed, or clockwise, elastic set or strain, under the stress of the electric flux, which stress is supposed to be re-

sisted by the elastic rigidity of the ether. The stress is a maximum at the axis O A. If the ether gives way, by the disruption of the air particles at this point, the rigidity fails to oppose the stress, and the ether flows clockwise bodily in the magnetic stream lines of Fig. 12. It comes to the same thing, therefore, whether we view, in imagination, the collapsing electric flux during the sudden discharge of the system, and watch the magnetic flux rings spring into existence with the downward electric motion, or whether we view in imagination the ether give way under the screw twist of the original charge, and watch the flow of the ether in obedience to that twist when the spark occurs at the axis.

*Electromagnetic Wave Generated by Sudden
Collapse of Electric Flux Distribution*

The ring magnetic flux, as in Fig. 12, accompanies the collapsing electric flux down the rod; it also sets up, by reaction, an external wave of upward and outwardly rising magnetic ring flux in the counter-clockwise direction. This rising magnetic flux sets up in its turn electric flux across itself. The direction of this rising shell of electric flux is indicated in Fig. 13 at A C and A D. It is directed from the rod to the disk, as in the original charge distribution of Fig. 7.

This hemispherical shell of downward electric flux, and ring magnetic flux, expands radially outwards in all directions at the light-speed.

The collapsing ring magnetic flux of Fig. 12, when it reaches the disk, is reflected back and up



FIG. 13.—Electric Flux Induced by the Ring Distribution of Magnetic Flux in Fig. 12.

the rod, still clockwise in direction, but moving upwards immediately behind the shell C B D. It sets up an electric flux in the directions indicated at A, Fig. 13. The two concentric hemispheres of electric and magnetic fluxes detach themselves from the rod in the manner diagrammatically indicated in Fig. 14. In the external hemispherical shell w P w, the electric flux is downwards and the magnetic flux lies in counter-clockwise rings centered on the polar axis B P. In the internal hemispherical shell x Q x, the directions are reversed, the electric flux being upwards, and the magnetic clockwise.

In a very brief interval of time after the discharge of the system by the passage of the spark, we have complete disappearance of electromagnetic charges, fluxes and energy in the rod-

and-disk system, while a hemispherical electromagnetic wave moves off radially with the light-speed, the radius of the hemisphere being theoretically 300,000 kilometers (186,400 miles) after one second of time. The thickness of the

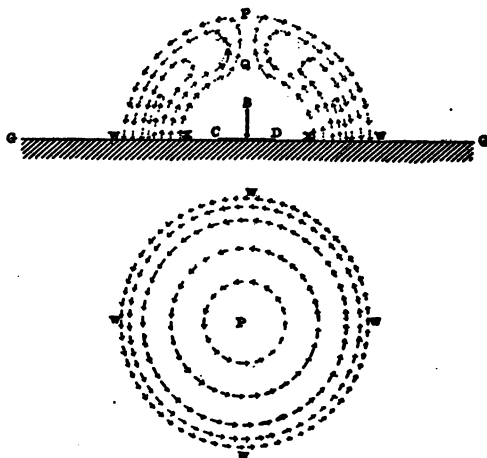

FIG. 14.—Vertical Cross-Section and Plan of Single Expanding Electromagnetic Wave.

double-layered hemispherical shell remains constant, but since the energy in the shell also remains constant, in the absence of absorption, the density of the fluxes and their energy per unit of volume rapidly diminish. In other words the energy per cubic meter of space in the wave rapidly diminishes.

The feet of the electric flux lines skim over the surface of the ground, assumed to be perfectly conducting. At the external edge w w w w, a negative ring charge runs out radially over the ground surface at the light-speed. At x x, a similar positive ring charge runs out radially at the same speed. This succession of running electric charges, linked together by loops of electric flux, constitutes a single *cycle of alternating current* flowing along the ground.

From its external aspect, the expanding hemispherical electromagnetic wave has electric flux distributed along meridians of longitude, symmetrically disposed with respect to the polar axis B Q P. The magnetic flux is distributed in circles of latitude, the smallest circles being near the pole, and the greatest near the equator or ground surface.

*Resemblances Between Solitary Explosion Waves
of Sound and Electromagnetism*

The solitary hemispherical electromagnetic wave of Fig. 14 bears some resemblance to the solitary hemispherical sound wave in air of Fig. 3. Each consists of a double layer, the disturbance in the external layer being of the opposite sign to that in the internal layer. On the other hand, there are notable differences. There is an

enormous difference in speed (nearly a million to one). The electric wave has a polar node at P Q and the sound wave has none. The electric wave is propagated in the ether, the sound wave in a gaseous substance.

If the earth's surface is not perfectly conducting, and in practice it is far from being perfectly conducting, the electric flux will penetrate to some extent into the soil, carrying also magnetic flux with it. The fluxes which sink in this way expend their energy in warming the soil very slightly and the hemispherical wave is thereby drained of a part of its energy, or is subjected to frictional losses in running along the ground. The energy per cubic meter of wave shell will thus diminish more rapidly than would be accounted for by the mere increase in bulk of the expanding wave shell.

Electromagnetic Wave-trains

The discharge of a rod-and-disk electrified system does not ordinarily give rise to but a single electromagnetic wave, such as is depicted in Fig. 14. On the contrary, the discharge generally gives rise to a series, or train, of successive waves of diminishing amplitude, each feebler than its predecessor. The rate of diminution depends upon the amount of heat expended in

the discharge spark, and to a lesser extent upon other structural details, but the amplitude of oscillation usually falls to one half, or loses fifty per cent., in about two complete swings, or after two successive waves have been thrown off. If the spark remained uniform, the amplitude would in such a case fall to one half again in two more swings, or to one quarter of the original amplitude in a total of four swings, or to one eighth in six swings and so on. Consequently, the amplitude of the successive waves emitted by a simple rod oscillator soon dwindles into insignificance.

Analysis of Oscillatory Current on Rod and the Generation of Waves

It may be of interest to consider in some detail the process of emitting a train of hemispherical electromagnetic waves from a rod-and-disk system laid on a perfectly conducting ground and suddenly set into electric oscillation by a spark discharge. Such a system may be briefly described as a *simple vertical oscillator*. Reference is made to Fig. 15, where the vertical rod is represented in nine successive stages of the process of manufacturing and shipping half of an electromagnetic wave, and two such diagrams would be

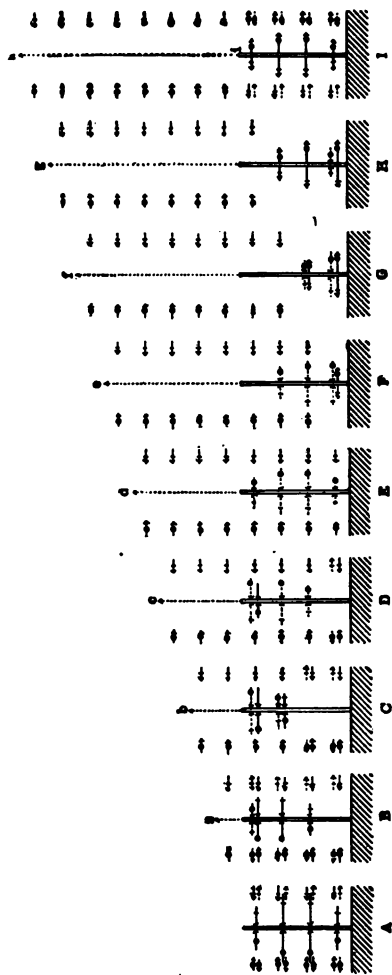

FIG. 15.—Diagram Indicating the Process of Emitting an Electromagnetic Wave from a Vertical Rod, with the Electric and Magnetic Fluxes in Nine Successive Stages During One Semi-Period.

required to illustrate the delivery of one complete magnetic wave into free space. Instead of commencing with the insulated rod just prior to the spark discharge, as in Fig. 7, it is more convenient to commence with the condition indicated at A, Fig. 15, where the electric flux has just completed its movement at light-speed up to the top of the rod, or has climbed up to the summit of the conductor. The flux arrows touching the rod are pointing inwards, indicating a negative charge on the surface of the rod. Ascending electric flux is marked by solid arrows and descending flux by broken or dotted arrows.

Accompanying the upward movement of the converging flux which has culminated in the condition at A, there will be, as previously stated, an associated magnetic flux. The direction of this magnetic flux is indicated by the device of a small circle and a small upright bar, the former on the left-hand of the rod, and the latter on the right hand. The circle may be looked upon as the feathers, or heel, and the small *bar* as the point, or *barb*, of an arrow in a horizontal plane bent into a semicircle about the rod on the side remote from the observer. The device is illustrated in detail in Fig. 15a, where P Q is a vertical section, and *p q* a plan view, of a converging plane of electric flux terminating on the rod E F at its

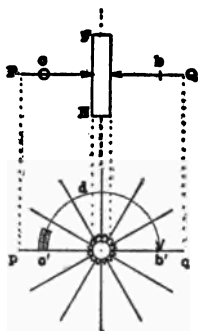

FIG. 15a.—Sectional Elevation and Plan of a Plane Electromagnetic Wave Ascending a Cylindrical Conductor, with Directions of Fluxes. Key Diagram to Fig. 15.

center and sliding upwards from E to F over the rod's surface, like a ring over a peg. When, as shown in Fig. 15a, the small circle *c* is on the left hand, and the bar *b* on the right hand, the ring magnetic flux *c' d b'* is disposed clockwise about the rod, as viewed from above. Counter clock-wise movement of magnetic flux calls for the circle on the right

hand and the bar on the left.

Rules for Memorizing the Directions of Motion, and of Electric Flux and of Magnetic Flux in Any Single Free Electromagnetic Wave.

There is a simple law connecting the directions of electric and magnetic fluxes in any simple plane electromagnetic wave. It may be expressed mnemonically in either of the following ways:

(1) Draw an arrow in the direction in which the electric flux points. Let the head of the arrow be supposed to be the head of a man who

runs in the direction in which the flux is running. Then the man's side-extended right hand will point in the direction of the magnetic flux. This rule is illustrated mnemonically in Fig. 16. The

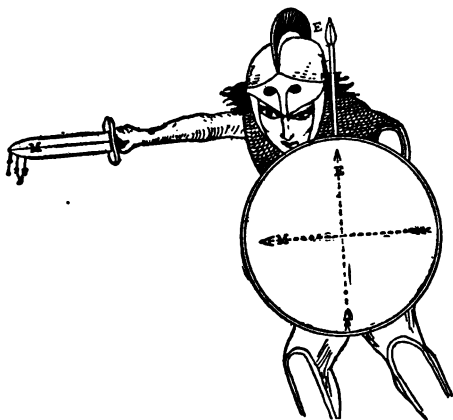

FIG. 16.—Memory Picture for Recalling Directions of Electric and Magnetic Fluxes in Waves.

point of the Greek warrior's sword is supposed to be magnetized and supporting iron nails.

(2) When electric flux, converging upon a conducting rod or cylinder, as in Fig. 15a, points its arrows inwards like the V's in the face of a clock (See Fig. 17), then if the flux is moving—like the light that makes them visible—from the clock towards the observer, the magnetic flux M will point circularly in the direction of the Motion of

the clock hands. Reversing either the electric arrows E , E , E , or their movement towards the observer, reverses the direction of the magnetic flux; but reversing both, leaves the magnetic flux M pointing clockwise.

Release of Electromagnetic Wave from Simple Rod Oscillator

Applying either of the rules to the upwardly moving and inwardly pointing horizontal electric

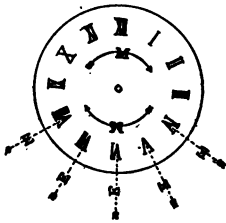

FIG. 17.—Mnemonic Clock Diagram of Relative Directions of Electric Flux E and Magnetic Flux M in an Electromagnetic Wave Coming Towards the Observer and Surrounding a Conductor at the Center.

flux on the rod at A, Fig. 15, it will be evident that the magnetic flux is directed clockwise, as viewed from above.

The moment the electric flux reaches the top of the rod it is reflected from the free end. Reflection of electric flux from a *free* end always requires the direction of the magnetic flux to be reversed, leaving the electric flux arrows unchanged in direction, but moving backwards, or retreating. This relation is a consequence of either of the above rules. Referring to Fig. 15a, the flux which has reached

the top of the rod at light-speed must keep on moving, and since it can go no further upwards, it commences to descend at light-speed. In Fig. 15, descending electric flux is shown by dotted line arrows and ascending flux by heavy line arrows.

The reversal of the direction of motion of magnetic flux around the rod, in changing from going up to coming down, delivers a blow, by inertia, to the surrounding external ether. In other words, the jerk required to reverse the magnetic flux around the rod between stages A and E of Fig. 15, sets up a counter-jerk or kick in the surrounding ether. The kick sets up two free waves traveling in opposite directions. The electric fluxes in these two waves are mutually opposite; but the magnetic fluxes conspire clockwise. These relations are indicated by the external pairs of arrows at A, which start into existence at the instant of reflection of the central wave from the top of the rod.

At the instant of time represented at B, the second stage, there has been a movement of the flux gliding over the rod, and also a movement in each of the two external free waves. Taking these in order, the gliding flux has commenced to move down at the top, or to double back upon itself, the three lower layers still climbing, but the

leading layer descending. The electric flux arrows point inwards at all parts of the rod, but the magnetic fluxes are opposed at the top, or tend to neutralize there. In the external waves, the ascending one has advanced one stage, and its wave-front is at a . The descending one has reached the conducting disk, or ground, at the base, and has been reflected from this surface. Reflection at a normal conducting surface entails reversal of the electric flux arrows but no reversal of the magnetic flux arrows. Consequently the lowest layer of the free external descending wave at A has turned its arrows from outwards to inwards, and the ring is moving bodily upwards.

At the next stage, indicated at C, the leading half of the wave on the rod has doubled back on the following half, the electric flux all pointing inwards, and the magnetic fluxes completely neutralizing. There is no resultant magnetic flux at this instant around the rod. In the free external waves, the ascending front has reached b. Half of the external wave which commenced moving downwards at A, has doubled back upon itself and is ascending.

Continuing this process to E, we find that the electric flux slipping on the rod is now all moving downwards and the magnetic flux is all counter-

clockwise. This means in ordinary language that the electric current in the rod is at this instant a maximum in the downward direction. The electric flux arrows all point inwards, so that there is a negative electric charge all over the rod. In the external ether, the direction of motion is altogether upward, with the electric flux inward and the magnetic flux clockwise. The front of the emitted wave has now reached d .

A new spark will now cross the air-gap at the base of the rod, not shown in the Figure, and the electric flux will pass over the conducting spark column to the ground at the base. It is reflected back from there with reversal of electric flux arrows, but persistence of magnetic flux; so that there is no kick or disturbance generated this time in external space. At F, the head of the wave conducted to the ground over the rod has turned around and is ascending. The external free wave has reached e and is clear of the ground.

At G, there is complete neutralization of electric fluxes, there being no resultant charge on the rod at this instant. But the current wave, as gauged by the conspiring magnetic flux, is at its maximum, and directed upwards.

In the last stage, at I, the flux gliding along the rod has reached its full development in the

upward direction, and is about to be reflected back from the free end at the top. This will involve a reversal of magnetic flux and a new shock to the surrounding ether, but in the opposite direction to the shock delivered at A. A new pair of oppositely moving external waves is thereby created, as indicated at I.

After eight more stages have been passed, the external wave will have completely deployed, and the length of this emitted wave will be just four times the length of the rod. The half wave contained between h and i, at I, is twice the length of the rod.

Reviewing the various stages, it will be evident that the electric flux reaches its maximum resultant value near the top of the rod; while the magnetic fluxes, on the contrary, are always in opposition at reflections from the top and reach their maximum near the bottom. This is another way of saying that the electric charge, and electric *voltage* or *potential*, develop maximum amplitude in oscillation at the top of the rod, and the electric *current* at the base.

The diagram of Fig. 15 must not be interpreted too literally. The actual flux distributions are somewhat more complex, and the radius of the emitted wave at I, say, is not exactly equal in all directions to the height h I. The emitted wave

becomes sensibly hemispherical, however, after the radius has acquired the length of one-half wave. It is sufficient to observe that there are two sparks for each complete electromagnetic oscillation, and one complete oscillation of electric pressure and current on the rod is accompanied by the emission of one complete free

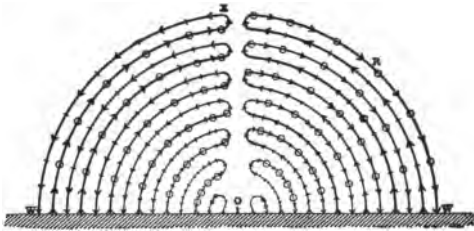

FIG. 18.—Train of Seven Hemispherical Electromagnetic Waves of Decaying Amplitude Liberated by a Rod Oscillator at Center.

hemispherical wave into space. The energy contained in the fluxes of the wave are drawn from the energy of the fluxes oscillating up and down the rod, which are thereby constantly being weakened, and reduced in density.

A diagrammatic vertical cross-section of seven complete hemispherical waves is seen in Fig. 18, as emitted from a simple rod and grounded disk oscillator o at the center. The first wave has attained the radius ow , about 28 rod-lengths from the center; while the seventh wave has just

been released. The first wave was the most powerful and is represented in the heaviest lines. Each successive wave is weaker and weaker. It should be remembered, however, that the heaviness of the lines in the illustration only relates to the strength of each wave at the moment of its release, or at the moment when it passes a given point; for as each wave expands, its energy per cubic meter or cubic foot rapidly diminishes, because the volume occupied by the wave rapidly increases. Consequently, the energy per cubic meter in the first and strongest wave, by the time it has reached the position $w \times w$, may be much less than the energy per cubic meter in the shell of the last and feeblest, but most condensed, wave at the center, O.

At any point, R, the advance of the wave is in the radial direction O R, at the speed of light.

The directions of electric and magnetic fluxes in this train of waves is indicated by the devices already used in Figs. 15 and 15a.

Deviation of Electromagnetic Waves from the Hemispherical Form Owing to the Curvature of the Earth

According to the theory above outlined, the hemispherical waves of Fig. 18 would travel over a perfectly flat conducting ground surface at

light-speed and the polar radius $o x$ would be 300,000 kilometers (186,400 miles) long after one second. In practice, when such waves are thrown out by a rod oscillator we have to deal with a moderately conducting spheroidal world surface. This changes the shape of the waves and makes them less geometrically simple. The waves will conform to the curvature of the earth and sea, the successive rings of positive and negative charge running out in all directions over the earth's surface at light-speed, and the feet of the electric flux shells gliding along with them. The waves continue to weaken in intensity per unit of volume as they run, both on account of expanding volume, and owing to sinking into the imperfectly conducting earth surface at their feet, *i.e.*, by frictional dissipation of energy in the ground.

*Condensation of Fluxes, and of Their Energy,
Towards the Equatorial Zone*

Although the direction of movement of these waves is always radially outwards, or perpendicular to the wave front, yet the density of the electric flux in each wave is not uniform all over the surface of the hemisphere. It is greatest near to the ground, and least near to the pole. This is roughly indicated in Fig. 14. Some of the up-

ward electric flux in the inner hemispherical shell turns back to the earth a short distance above the surface. The higher we rise in the shell, the less flux we find in it, and when we reach the polar axis Q P all the flux has ceased. The same condition necessarily attaches to the associated magnetic flux in the wave. The result is that the energy contained in unit volume of either or of both fluxes near the ground is greater than it would be according to simple uniform distribution, by about 60 per cent. In other words, the flux densities and energy in any hemispherical electromagnetic wave are greatest at the ground or equator and dwindle towards the pole.

Relations Between Wave-length, Frequency, and Periodic Time

From the relation that the length of the waves emitted by a simple vertical rod oscillator is four times the length of the rod, we can readily find the duration of each wave as it passes any point on the ground or in the air above. Let us suppose that the oscillator is kept supplied with electric energy so as to keep sending out waves for just one second of time, and that the length of the rod is, say, 25 meters (27.34 yards). Then the length of each wave would be 100 meters (109.36 yards) measured along any radius. But

in one second of time, the radius of the outermost wave would have reached to 300,000 kilometers (186,400 miles) and this distance would cover 3,000,000 such wave-lengths. It is clear then that the oscillator must have emitted three millions of waves in the one second of time considered, and also that the time occupied by the wave to pass a given point would be $\frac{1}{3,000,000}$ of a second. This is stated in the customary phraseology by saying that the *frequency* of oscillation is 3,000,000 cycles per second and that the *periodic time* of such waves is $\frac{1}{3,000,000}$ second. In a similar manner, if we know any one of the three quantities wave-length, frequency, or periodic-time of an electromagnetic wave in air, we can instantly assign the other two, because the velocity of propagation is the light-speed in air of 300,000 kilometers (186,400 miles) per second. It is believed that there is hardly any difference between the speed of light in air and in free ether space devoid of air.

CHAPTER VII

UNGUIDED, OR SPHERICALLY RADIATED ELECTRO- MAGNETIC WAVES

Generation of Spherical Electromagnetic Waves by the Discharge of a Double-rod Oscillator

IF we take a pair of conducting rods A B, C D, and suitably support them insulated in line with each other as indicated in Fig. 19, then on charging the system electrically, with the rod A B, say, positive, the electric flux lines will permeate all the surrounding air in the distribution roughly depicted. So long as the insulation is maintained there will be no magnetic flux. If, however, we raise the electrification to a point at which the air breaks down between the two opposed extremities B C, the electric flux system collapses and runs in towards the spark. At the same time magnetic flux is generated in rings around the axis A D by the inrushing electric flux. The sudden generation of magnetic flux gives a shock to the surrounding ether which sends off a spherical electromagnetic wave into surrounding space at light-speed.

UNGUIDED ELECTROMAGNETIC WAVES 65

The contours of five successive spherical waves is given diagrammatically in Fig. 20, with reference to the pair of discharging rods at *o*, the center of disturbance. If the two electrified rods

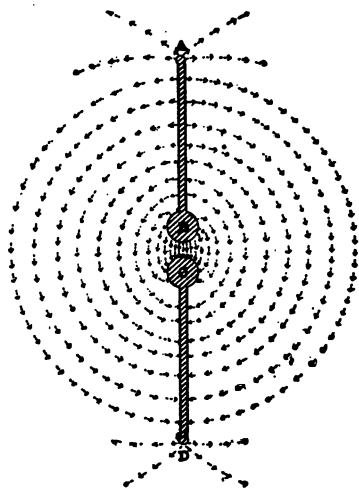

FIG 19.—Electric Flux Between Oppositely Charged Conducting Rods.

have no source of energy to maintain their oscillations except the original charge, the successive outgoing waves carry that energy away, while some of the remainder is dissipated in heat in the spark and also in the surfaces of the rods, so that the oscillations rapidly die away. It is not impossible, however, to supply electric energy to

the rods as fast as it is radiated externally and dissipated locally, so as to maintain the oscillations indefinitely, although it is very difficult to do this experimentally. In such a case, the wave

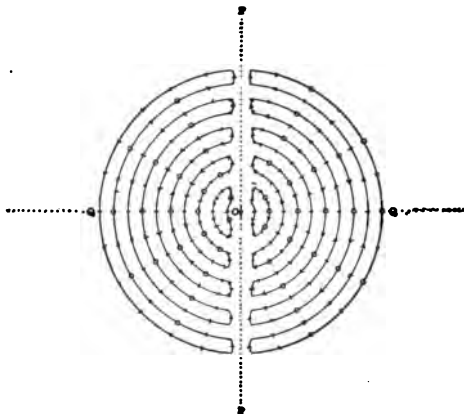

FIG. 20.—Diagram of Section through the Polar Axis of a Train of Five Spherical Electromagnetic Waves Emitted by a Double-Rod Oscillator at the Center.

train would go on extending and expanding indefinitely at light-speed. If the rods could somehow be placed in free space, remote from the earth and all conductors, the spherical waves would keep on moving radially outwards. In practice, on this earth, the waves must almost immediately strike the surface of the ground on one side at least, and be reflected there, not to

speak of the influence of neighboring walls, trees, etc., so that the pure spherical form cannot be maintained.

Figure 20 shows that the polar axis P P is in the line of the rods at the center o. On this axis the electromagnetic fluxes and energies disappear. At and near the equator Q Q, the fluxes are densest and their energies are a maximum, for any given radial distance from the center. The length of each wave is four times the length of either rod, as in the hemispherical waves considered in the last chapter; or it is twice the length of the double-rod oscillator A D of Fig. 19.

Spherical Electromagnetic Waves Identical with Long-wave Polarized Light

Physicists are now agreed that such an oscillator as above described, if kept supplied with energy for radiating electromagnetic waves, would emit *light*. That is to say, such electromagnetic waves constitute light; although not ordinary light such as is recognized by the eye. The main difference between such waves and ordinary light lies in the wave-length. The human eye is able to recognize as light electromagnetic waves whose length lies between the

limits of 0.4 micron* ($\frac{1}{25,000}$ inch), in violet light, and 0.8 micron ($\frac{1}{12,500}$ inch) in red light. Electromagnetic waves which are either shorter or longer than this are not directly visible; although they may still be objectively regarded as light.

Modern Electric Theory That All Matter is Ultimately Electricity

Ordinary matter, such as a piece of matchwood, is believed to be made up of ultimate particles called molecules, too small to be seen by the microscope. Molecules are chemical combinations or chemical groups of atoms. Atoms are the supposed ultimate particles of elementary substances, or the smallest pieces of such elementary substances which can exist separately as such. Atoms in their turn are now supposed to be each constructed of much more minute or ultra-ultra-microscopic electrical charges, called *electrons*, there being a definite number and organization of electrons to each atom of an elementary chemical substance. Consequently, all the matter in the universe is ultimately constructed, according to this theory, of definitely

* The micron is the term used in microscopy for the one-millionth part of one meter from the Greek *mikros*, small. It is usually designated by the Greek letter μ .

organized electric charges, or of electricity. An atom of hydrogen, for example, is supposed to comprise about 800 electrons in some definite organized orbital or planetary movements, an atom of oxygen about 10,000 electrons in a different grouping of orbits; and so on, for other elementary substances.

When atoms are heated, as for example, the hydrogen and carbon atoms of wood, by setting fire to a match, the electric charges or electrons within the atoms are regarded as being forced into rapid and violent oscillation, whereby electromagnetic waves are radiated off. Since these atomic oscillators are of ultra-microscopic dimensions, so too are the lengths of some of their electromagnetic waves. Those waves whose lengths lie between 0.4 and 0.8 micron are perceived by our eyes as light. A pair of little rod oscillators, as in Fig. 19, each about 0.2 micron long ($\frac{1}{120,000}$ inch) excited into sustained radiation, would give off waves of red light, the longest waves by which the retina of the eye is affected.

Virtual Ultra-microscopic Oscillators in Heated Matter and Their Emitted Waves

Looked at in another way, the shortest electromagnetic waves that have yet been produced by

the discharge of electric rods or spheres are a few centimeters, or inches, in length. In order to make visible light in the same manner, we should have to use ultra-microscopic particles as discharging bodies. On the other hand, the waves employed in wireless telegraphy usually vary between 100 meters (109.4 yards) and 10,000 meters (6.21 miles) in length. The latter would include in one wave length 25,000,000,000 waves of violet light, the shortest detected by the human eye.

The velocities of all electromagnetic waves being apparently the same, whatever their length, their frequencies differ in a similar range. The frequency of a 10-kilometer (6.21 miles) wave would be 30,000 cycles per second, or each oscillation would occupy $\frac{1}{30,000}$ second in execution. But the frequency of violet light is 760 millions of millions per second. Each color of the spectrum has its own frequency and corresponding wave-length.

There is one other difference between visible light and spherical electromagnetic waves produced by electric discharge between conductors as in Fig. 19. This is in regard to the directions of the poles of the waves. In Fig. 20, the polar axis of the waves always lies in the line of the rods, no matter how far the waves may extend into

space. There is no energy emitted along this axis. Let us suppose that the rods are ultra-microscopic, so that they are enabled to emit waves short enough to affect the eye, and that their energy of oscillation is somehow sustained. Then the point o in Fig. 20 would be a luminous point, shining with one particular color of the spectrum. The brightness of the point would, however, be greatest in the equatorial plane $Q Q$, and it would dwindle to zero as we moved the eye to the polar axis. An eye at Q would see the shining point; but an eye at P would see nothing. This is contrary to experience with glowing material points. A lighted match or glowing point, sends out rays in all directions.

The discrepancy is accounted for by the fact that the polar axis of the electric disturbance in a luminous point, supposed to be due to oscillating electrons, is constantly shifting its direction in space. One wave may have its polar axis vertical, but after a few more have passed by, there will be a wave with its axis horizontal, and later again the axis will be vertical; so that in a single second of time including millions of millions of waves, the atomic electric oscillators will have turned into all directions and will have made many gyrations. Consequently the eye will have received in that time many waves in

their equatorial zone and also many in their polar zone, so that the average effect will be the same in every direction. We need only suppose the rod oscillator of Figs. 10 and 20 rotated about the spark center in all directions at great speed during the emission of a long train of waves, to see, in imagination, the effect that would be produced upon the eye of an observer at any distant point.

Electromagnetic waves or light waves in which the polar axis remains fixed in space, as in Fig. 20, are called *plane-polarized* waves. The *plane of polarization* is the equatorial plane $Q O Q$, parallel to which all the magnetic flux-paths are disposed. Ordinary, or non-polarized, light may be artificially plane-polarized by optical methods.

We may say then that ordinary visible light consists of electromagnetic waves of sustained amplitude—*i.e.*, not merely a few decaying oscillations—within a certain sharply limited range of small wave-lengths or high frequencies, and with the polar axis in all directions in rapid succession. Ordinary daylight contains almost all the wave-lengths within the visible range, showing that vast numbers of atomic oscillators of different “lengths” are simultaneously operating in the glowing solar surface and are mingling or superposing their electromagnetic waves. These

waves reach us in about 500 seconds after they leave the atomic electric oscillators in the solar atmosphere.

*Solar Wireless Telegraph Waves, in Broad Sense,
Necessary to Life of Human Beings*

In a certain sense, therefore, every shining star in the heavens is constantly sending out spherical electromagnetic waves within the range of visual perception, besides probably many longer waves, outside of that range. In this particular sense we are constantly receiving wireless telegraph waves from every visible orb, and the message received is not news but light. Moreover, since all animal energy is derived from plants, and all plants build up their substance from the energy contained in the sunlight they receive, it follows that all our muscular energy is derived indirectly from wireless telegraph waves received from the sun.

Union of Optics with Electromagnetics

All of the phenomena of light, reflection, refraction, polarization, interference, etc., which have been within the special study of Optics for many decades, have in recent years been imitated, on a relatively large scale, by electromagnetic waves set up by the discharge of elec-

trified conductors. In fact, a few of the properties of optical waves which are difficult to detect, by reason of the excessively short optical wavelength, are more easily studied and revealed in electromagnetic waves in the electrical laboratory.

Classification of Types of Electromagnetic Waves

Summing up the conclusions reached in the last few chapters, we may say that discharges between two rods or conductors set up spherical waves. Discharges between a conductor and a plane conducting surface, such as the ground approximates, set up hemispherical waves. Waves guided between a pair of parallel wires; and between an aerial wire and the ground are cylindrical waves, moving end-wise. The waves employed in ordinary wireless telegraphy are initially hemispherical waves conforming to, or guided by, the spheroidal earth.

CHAPTER VIII

PLANE ELECTROMAGNETIC WAVES

Hemispherical Waves of Large Radius Are Virtually Plane at Any One Point

ANY small section or piece cut from the front of a hemispherical wave is practically flat, or plane, when the wave is remote from its origin, just as the earth's spherical surface is practically flat, or plane, at any one point on the ocean, because its radius is relatively so large. Consequently, any hemispherical wave advancing over the surface of the earth or sea may be regarded as plane locally. It comes along like an invisible upright wall.

A section of a single such wave is shown in Fig. 21, taken along the line of march V V. G G represents the surface of the ground. The electric flux rises perpendicularly at P P, or very nearly so. If the earth conducted perfectly, the electric flux would rise strictly vertical from it. Imperfect conductivity causes a wave to lean over, or bend forward slightly, as it moves, so that a perpendicular to the wave front would no

longer lie parallel to the ground but would point into it. For practical purposes, however, we may take the electric flux as perpendicular.

In the front half of the wave, we have taken the flux P P as pointing upwards, corresponding to a moving positive charge on the ground beneath; while in the rear half these conditions are reversed. This relation of directions depends upon the direction of the fluxes in the oscillator at the moment that this particular wave was born.

The amplitude of the current waves on the ground are indicated by the curved line f p o n r. The line of zero current is the line z f o r z. The direction of the magnetic fluxes is also indicated, by circles where the flux is directed away from the observer and by short horizontal bars where towards the observer.

The wave front has reached F F, while the rear of the wave is at R R. The wave-length is, therefore, the horizontal distance F R. At the central vertical plane O O, midway between the positive and negative developments of the wave, the fluxes are zero and their energies are consequently zero. The fluxes are densest at the central planes P P and N N, and their energies in a given volume are also a maximum at these planes.

In practice, there will usually be a train of successive waves moving over the ground in place of the solitary wave of Fig. 21. A wave

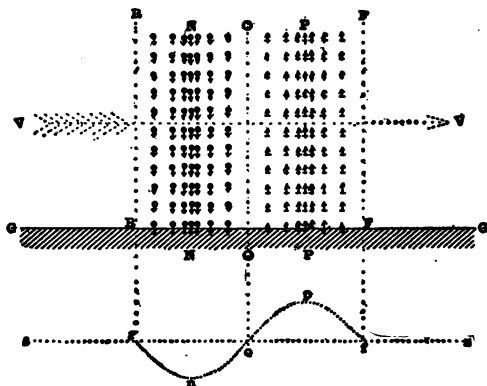

FIG. 21.—Section of a Single Electromagnetic Wave Along Line of Advance and Near to Surface of the Ground.

train in wireless telegraphy does not usually contain many waves, and their amplitude successively diminishes; so that the final waves in the train are extremely feeble.

Analysis of a Single Wireless Telegraph Wave At and Near the Earth

A section of the wave in the plane of P P, Fig. 21, is given diagrammatically in Fig. 22. It appears as a number of parallel equidistant, ver-

tically rising, electric flux lines, crossed at right angles by a number of parallel equidistant horizontal magnetic flux lines. This means that both the electric and the magnetic fluxes have uniform intensity in this plane. The charge moving upon

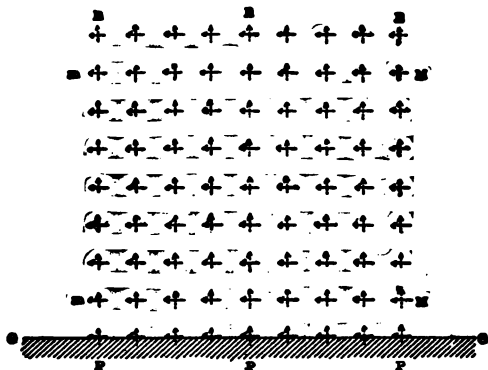

FIG. 22.—Diagrammatic Section of Plane Vertical Electromagnetic Wave Parallel to Wave-Front and Advancing Towards Observer, with Electric Flux Rising Vertically from Positive Charge on Ground and Magnetic Flux Horizontal.

the surface of the ground below the wave is positive. Since the ground is not a perfect conductor, the fluxes penetrate into it to some extent. This causes a certain amount of energy to be expended in the penetrated layer of soil as heat, derived from *eddy currents*, of parasitic electric currents, in the soil. The energy expended at

the foot of the wave has to be paid for from the stock of energy residing in the wave as a whole; so that energy is fed downwards as the wave runs along, causing a weakening of the moving fluxes, in addition to the weakening caused by the simple hemispherical expansion of the wave.

Electric and Magnetic Forces Embodied in the Wave and Moving Therewith

If we could compel the wave to stand still for a moment, instead of running by the observer at light-speed, we should expect to find that a positively electrified pith ball would be urged upwards by the upwardly pointing electric flux of the wave as depicted in Fig. 22; while a delicately poised magnetic compass needle would tend to align itself along the lines $M m$ in the wave front. In any ordinary wave, however, these electric and magnetic forces would be of very feeble magnitude. The fact that they are able to produce recognizable effects as they pass by is due to their enormous speed, the speed of light in the medium.

Transparency of Electric Non-conducting Obstacles to Long-wave Light

When a plane electromagnetic wave, many meters or yards long, running along the surface

of the ground, strikes a brick wall, or a wooden-frame house devoid of metal, it passes through these obstacles with very little disturbance. This means that if our eyes were capable of responding to these waves, so that they produced the sensation of some type of color, such non-conducting obstacles would be transparent to that color of light, and we could look through a brick house or a wooden house without difficulty, when objects were illuminated by these waves, or in this imaginary type of color. If, however, the advancing waves strike an electrically conducting obstacle, such, for example, as a simple vertical metallic rod, indicated in Fig. 23, the obstacle will either absorb or reflect the waves and will cast a shadow beyond it, the shadow being, of course, invisible to us; since the waves are invisible; but the shadow can be determined and mapped out by suitable electric apparatus; or by what may be called an artificial eye.

Shadow Cast by a Vertical Electric Conductor in the Path of an Electromagnetic Beam

The electric flux only is indicated in Fig. 23 advancing from left to right, over the ground G G. At *a*, it is about to strike the vertical metallic rod A B, connected with the ground. Such a vertical might be a leaden water-pipe, or

a copper wire. At b the wave has passed the vertical and a gap has been thereby torn in the wave. The lower edge of the wave at the rent is bent backwards and the subsequent direction of movement of this edge, being always perpendicular to the local surface, is downwards as well as

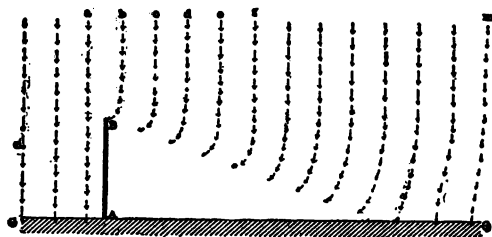

FIG. 23.—Diagram Indicating the Electromagnetic Shadow Cast by a Vertical Conductor in the Path of an Advancing Plane Wave.

to the right. In the successive positions $c d e f$, the wave is spreading down from above, and at m the rent in the wave net has been repaired, or the shadow behind $A B$ has been filled up, the energy of the flux put into the patch being drawn from the remainder of the wave. It is to be understood, however, that the diagram of Fig. 23 makes no pretensions to geometrical accuracy, and the exact contour of the shadow thrown by a conducting obstacle is not yet determinable with precision.

After the wave has struck the rod A B, a disturbance is reflected back from the rod into the region A B n G, at the same time that the shadow

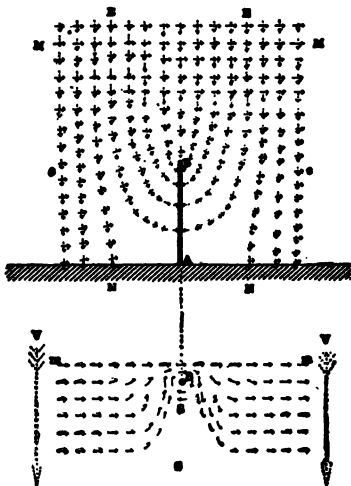

FIG. 24.—Diagrammatic Sections in Elevation and Plan of Electromagnetic Wave Striking a Vertical Conductor while Advancing Towards Observer.

is cast beyond. This reflected disturbance is, however, omitted from the illustration.

Fig. 24 presents a sketch, both in elevation and in plan, of the actions occurring when the wave strikes the vertical conductor. The wave is supposed to be advancing towards the observer. It will be seen that the electric flux, which is every-

where distributed as in Fig. 22 (reversed), before it strikes the vertical A B, is drawn in on each side to the rod and converges on the same, continuing to run down the rod for a little while after the wave has passed. The magnetic flux is shown in the plan at the base of the illustration. Before the wave reaches the rod, as at m m, the magnetic flux lies in a horizontal straight line, parallel to the wave front. As soon as the wave strikes the rod, the magnetic flux bends around it clockwise, and also descends the rod at light-speed. S S is the shadow cast by the rod B, or the space denuded of magnetic flux for a certain distance behind B.

Looking at the action from another standpoint, we may, in the light of our provisional electromagnetic theory, consider that the electric flux advancing over the ground brings a local right-handed torsional stress upon the ether, which, by electric rigidity, resists the stress and limits the flow of ether to that small amount found in the wave front as indicated by the horizontal magnetic flux lines M M, Fig. 24. At soon as the electric flux strikes the conducting rod A B, the elastic rigidity of the ether is lost, owing to the action of the conductor and the electrons residing in it. The ether at the rod gives way before the stress, and flows bodily around the rod

in dense magnetic flux streams. On such a hypothesis, a conductor behaves like a gap in the ether, and the advancing electromagnetic wave pours electric and magnetic fluxes spirally or vortically down into the gap as it goes by.

Comparisons Between Reflection of Short and Long Waves of Light

Whatever hypothesis we adopt to assist the mind's eye in depicting the process, we must expect to find the action similar to that which occurs when half-micron electromagnetic waves, *i.e.*, visible light, strike an opaque obstacle. There is a reflected wave train thrown back by the obstacle. There is also a shadow cast behind it, and there is energy absorbed into the substance of the obstacle. The width of the shadow cast by a parallel beam of light is apparently no wider than the obstacle; whereas in Fig. 24, the shadow cast is indicated as being many times the width of the vertical rod. But it has to be remembered that if the optical shadow of a rod were one quarter of a wavelength wider than the rod, the difference would be only about a sixth of a micron ($\frac{1}{180,000}$) and quite insignificant; whereas if the rod A B had the same height as the simple rod oscillator which originally emitted the wave, a shadow hav-

ing a breadth of a quarter wave-length would be as broad as the height A B, or the distance N N in Fig. 24, and would be equal to the height A B, a very appreciable distance.

Gashes Torn in Electromagnetic Waves by Vertical Conductors on the Earth

It is evident that upright metallic rods, such as lightning-conductors, tear rents in any passing electromagnetic wave running along the ground. On the other hand, a conductor parallel to the ground, such as a trolley-wire, or an overhead telegraph wire, does not sensibly affect a passing electromagnetic wave. Looked at in another way, a vertical rod is cut by the rushing horizontal magnetic flux at light-speed, and acts like a single-wire dynamo, moving through a very feeble magnetic field at the speed of light. Again, a vertical rod picks up a certain difference of electric potential between the electric flux at its top and at its base. In either of these ways, the rod becomes the seat of an electric impulse or *electromotive-force* during the brief interval in which the wave is passing by it. But if we place the rod horizontal, instead of vertical, the electric flux in the wave will cut the rod perpendicularly and the magnetic flux, in cutting, only acts upon the thickness of the rod; so that the electromo-

tive force set up therein by the passing wave will be insignificantly small, and will be directed transversely or across the diameter of the horizontal rod.

Accordingly, when a single electromagnetic wave hits a vertical rod, a rent is torn in the wave, and the breadth of the rent, although not yet accurately known, may, perhaps, be a quarter of a wave-length. The energy which resided in the wave within the region torn out, is available for setting up electric currents in the rod, after allowing for what is lost by reflection and secondary radiation.

It may be readily imagined that when an electromagnetic wave strikes a steel bridge, or a steel sky-scraper office-building, it casts a long shadow, and a relatively large quantity of energy is torn out of the wave. Trees also, and shrubs too, in lesser degree, have been found to be feebly conducting, and it is believed that they absorb energy from waves passing them. This fact taken in connection with the imperfect conductivity of dry soil, in comparison with sea water, accounts for the considerably greater distance at which electromagnetic waves can be transmitted and detected over the ocean than over land. The signaling distance range over the sea is, roughly, double the signaling distance range across country.

Elementary Analysis of Electric Oscillations Set Up in a Vertical Conductor by the Passage of Waves

It is important to notice the principal events that occur in the neighborhood of the vertical rod after it has been struck by the onrushing electric wave. Fig. 25 indicates diagrammatically nine successive stages in half a complete cycle of these events. The line of crossed arrows immediately under the letters A B C I, represents the directions of electric and magnetic flux in the advancing wave over the rod. Thus at A, the conditions are those indicated in Figs. 23 and 24; namely, the electric flux is pointing downwards and the magnetic flux pointing to the right, as viewed by an observer who sees the wave advancing towards him. At E and F these fluxes are in the act of reversing through zero, corresponding to a plane such as O O in Fig. 21. At I, the fluxes have completely reversed.

Underneath each diagram of a rod section in Fig. 25, there appears a plan view showing the direction of magnetic flux in the wave just before striking the rod, and also of magnetic flux encircling the rod. Thus, at A, the magnetic flux in the air is at full development towards the right

hand of the observer, while around the rod it is clockwise. At C, the clockwise magnetic flux encircling the rod has reached full development, or the electric current over it is a maximum. Between E and F the magnetic flux in the air reverses or passes through zero. At G, the magnetic flux encircling the rod passes through zero. At I, the magnetic flux in the air-wave has developed completely in its reverse, or left-handed direction.

Examining the rod at A, it will be seen that the electric flux of the passing wave has converged upon it, as already seen in Figs. 23 and 24. This flux immediately starts to run down the rod to ground, as indicated by the long dotted arrow. The instant it begins to run, the electric flux reverses direction, or assumes the outward direction shown at B, the magnetic flux remaining clockwise, as viewed from above. As soon as the flux reaches the conducting ground at the base of the rod, it is reflected thence upward, with a new reversal of electric, and maintenance of magnetic, flux direction. At E, the stream of flux on the rod is about to reach the top. At the top, the flux reverses magnetically, or is reflected downward, with persistence of inward electric flux. At G, the magnetic flux is half clockwise and half counter-clockwise, representing zero of

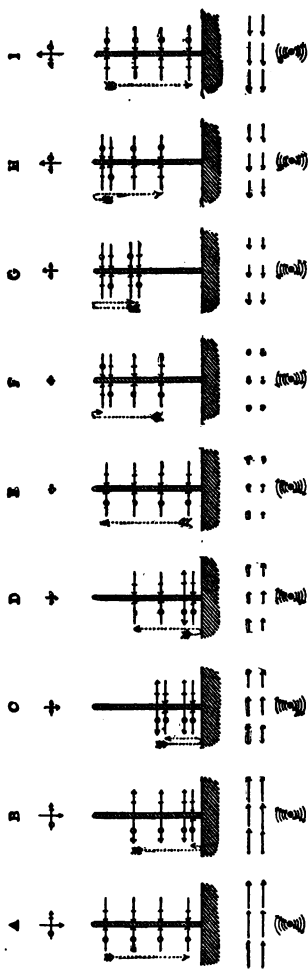

FIG. 25.—Diagram Indicating the Development of Magnetic and Electric Flux About a Vertical Conductor Struck by a Plane Vertical Electromagnetic Wave Advancing Over the Ground Towards the Observer.

current, but maximum electric potential. At I, the flux is in full descent again, with counter-clockwise magnetic field.

*Resonance in Electric Conductors Struck by
Wave-trains*

We have purposely chosen the length of the rod as one quarter of the length of the plane wave advancing through the air. This brings about such an adjustment of the motion of flux over the rod as enables the next succeeding wave to add to, or increase, the movement. If we extended the diagram of Fig. 25 through eight more such phases we should return to the original condition at A, when the flux in the next wave would not only repeat the cycle, but would also increase the amplitude. If the rod conducted perfectly, and also the ground at its base, each wave as it arrived through the air would add to the fluxes running up and down the rod, on the familiar principle of the child's swing, whose oscillations may be increased by timing the pushes to the natural period of oscillation. In this case, however, the swing of the rod is adjusted by its length, so as to be in rhythm to the train of arriving waves. Such a condition of coincidence between the times of arrival of the successive wave-crests,

and the natural time of electric oscillation of the rod, is called *electric resonance*.

If we could obtain a very long train of uniform advancing waves and adjust the length of the vertical rod into resonance therewith, retaining perfect conduction, the fluxes running up and down would increase indefinitely, were it not for secondary radiation. That is, the rod, excited in this way by arriving waves, would become an oscillator in its turn, and discharge the energy it received in a new series of radiating waves, as in Fig. 15. In practice, however, the waves received through the air have such feeble amplitude, they decay so soon, the number in a train is so small, and the conductivity of the rod and ground base is so far from being perfect, that even when the rod length is adjusted into resonance, the currents developed over the rod, as in Fig. 25, are comparatively feeble. The secondary radiation is, therefore, insignificant.

If the length of the rod is in the opposite condition to that required for resonance, the fluxes generated thereon by the first wave will be opposed, instead of aided, by the fluxes generated in the second, and so on. Consequently, there will be comparatively feeble currents set up on the rod. If, however, the length of the rod is adjusted for resonance, there will be a building

up of electric current on the rod, unless the arriving wave train is too short, or unless the electric obstruction and want of conductivity in rod and ground suppress the development.

In order to adjust the rod to the resonant condition, it is not always necessary to alter its height. The virtual length can be altered by the insertion of a suitable form of conductor or wire at the base, between rod and ground, in a manner to be described later. In such a manner the time of oscillation of a rod can be altered without changing the actual height.

*Résumé of Conditions Attending the Impact of
Waves Against Vertical Conductors*

Summing up the above results, we find that a vertical conductor connected with good conducting ground, and set up anywhere in the path of a train of electromagnetic waves, will have alternating, or to-and-fro electric currents set up on it, the energy contained in these currents being the energy in the up-and-down moving fluxes, which energy is drawn from, or scooped out of, the arriving electromagnetic waves as they pass by. These alternating currents in the rod are capable of being built up, or successively increased in strength, by the impulses of the successive waves, if there be resonance, *i.e.*, if the natural time of

oscillation of the rod be the same as the periodic time of the arriving waves. For a simple vertical rod, devoid of inserted apparatus, this will be when its height is one quarter of the wave-length, and therefore equal to the height of the simple vertical rod oscillator which is capable of originating such waves. In other words, if the arriving waves have been produced by a distant simple rod oscillator, resonance will require the heights of the oscillator and of the receiver verticals to be equal. Resonance would be capable, theoretically, of setting up an indefinitely great amplitude in a perfectly conducting receiver rod, set in perfectly conducting ground, with a constantly maintained succession of waves at the oscillator, were it not for secondary radiation of waves from the receiver. In practice, however, the alternating currents set up at the receiver may be materially increased by bringing the receiving rod into resonance, but the development is arrested by imperfect conduction at the receiver, as well as by discontinuity of the oscillations, or small trains of waves at the oscillator. Moreover, the insertion of a receiving instrument into the path of the vertical receiver rod also causes energy to be absorbed, and interferes with the production of resonant increase of oscillations.

Energy of Electric Oscillations, or Oscillating Currents, Set Up in a Vertical Receiver

The energy which is available for producing such electric currents by any wave at the receiver depends upon the energy in the entire hemispherical wave at that moment. It will evidently be but a very small fraction of the total energy of the wave, when the receiver is far from the oscillator, since the area of the wave which can come into contact with the receiving rod, or into its region of influence, is so small. If we suppose that the receiver has a height of a quarter wave-length, for resonance, and that the effective breadth of area from which energy is drawn, as in Fig. 23, is also a quarter wave-length, then the fractional part of the wave's energy available for producing electric current at the receiver, is the square of the height of the receiver rod, divided by the superficial area of the hemisphere occupied by the entire wave at the instant it strikes the rod. For example, if we suppose that a certain wave in a series emitted by an oscillator contains at the moment of shipment an amount of energy equal to 1 kilogramme-meter (7.24 foot-pounds, or the work done in lifting one pound through a vertical height of 7.24 feet), then a quarter-wave vertical receiving rod at a distance of 30 kilometers

(18.6 miles), with a height of say 31.6 meters (103.6 feet) might perhaps absorb energy from the wave as it passed, over a height of 31.6 meters and a breadth of 31.6 meters, or an area of wave surface amounting to 1,000 square meters (10,760 square feet). But, neglecting the curvature of the earth, the area of a hemisphere 30 kilometers (18.6 miles) in radius would be 5,655 millions of square meters (60,800 millions of square feet); so that the electromagnetic energy capable of being drawn on to the rod would be $\frac{1,000}{5,655,000,000} = \frac{1}{5,655,000}$ of a kilogramme-meter, or 17 ergs. The received energy should be about 60 per cent. greater than this, because of the greater density of flux and energy in the equatorial zone of the transmitted wave, *i.e.*, near the earth's surface. On the other hand, however, a distinct reduction would have to be made for the energy wasted in transmission along the surface of the soil, by reason of the earth's imperfect conductivity, or for other vertical conductors, such as metallic structures, or trees, intervening between oscillator and receiver.

Our knowledge is still very imperfect as to the effective surface area drawn upon by a vertical rod, and also as to the amount of energy drained from the feet of an advancing hemispherical wave by reason of the earth's imperfect conductivity.

This loss is known to be greater after dry weather than after rain. It is, however, clear that according to the working theory outlined above, the energy capable of being received by any such vertical rod increases as the square of its height, assuming that the resonant condition is maintained, and also inversely as the square of the distance between the sending and receiving stations. The total energy available for producing alternating electric currents at the receiver will be the sum of the successive fractional amounts drawn from each single wave in turn, assuming that the successive effects can be prevented from canceling or annulling each other, by the adjustment of the receiver to the resonant condition.

CHAPTER IX

THE SIMPLE ANTENNA OR VERTICAL ROD OSCILLATOR

The Antenna and Transmitting Apparatus

WE have already arrived at the conclusion from preceding chapters that wireless telegraphy ordinarily employs hemispherical electromagnetic waves emitted from a vertical rod oscillator or antenna, in short trains of from two to thirty waves of successively diminishing amplitude. On or near the ground, or sea level, and at a great distance from the transmitting station, these waves are for all practical purposes plane waves, advancing over the conducting ground, or sea, with the speed of light, in a direction radial to the sending station, after allowing for the curvature of the earth. We now proceed to consider the essential elements of the antenna, and of the apparatus employed, at the transmitting station.

The simplest type of vertical antenna or rod oscillator is represented in Fig. 26. It consists essentially of a single vertical metallic wire A B,

suspended from an insulator I, which is supported from a wooden mast structure indicated in dotted lines. This vertical wire, air-wire, aerial, or antenna, is insulated from the ground

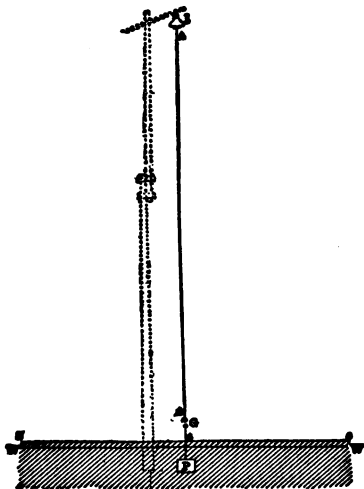

FIG. 26.—Essential Elements of a Simple Vertical Oscillator, or Antenna, for Emitting Hemispherical Electromagnetic Waves.

by the air-gap G, so long as it is electrically inactive. The lower terminal of the air-gap communicates with a metallic plate P sunk in moist earth, or below low-tide level, if on the seashore. Sometimes bare wires w w are laid out radially from the ground wire in various directions, at or

near the surface of the ground, so as to improve the local conductivity of the soil, and help to form a good electric mirror at the ground surface $s s$, from which the waves may be reflected back and up the antenna, not only at the conductor, but in its vicinity, as indicated in Fig. 15.

The length of the wave emitted by a simple vertical wire antenna as shown in Fig. 26 is believed to be very closely four times the height of the antenna $A B G S$. Thus, if the antenna had a height of 30 meters (32.8 yards), above perfect ground, the length of the waves sent out would be 120 meters (131.2 yards). The number of such waves which would cover the distance travelled by light in one second would be $\frac{300,000,000}{120} = 2,500,000$; so that there would be two and a half millions of such waves occupying one second, if the oscillator could be kept at work for that time. This means that the frequency of the waves would be 2,500,000 cycles per second, or the time occupied by any one complete wave to pass a given point would be $\frac{1}{2,500,000}$ th second. If we call the one millionth part of a second one *microsecond* for convenience of description, then one complete wave would pass off in $\frac{1}{25}$ microsecond. Since each wave contains both a positive and a negative impulse, either impulse would pass by in $\frac{1}{5}$ of a microsecond.

The Large Activity of an Antenna

Owing to this extremely short period of oscillation, antennas are remarkable for their activity or power. The amount of energy which can be stowed away in a simple vertical antenna as electric-flux energy in the surrounding ether, by charging it to a suitably high voltage, is comparatively small, being usually not more than 20 gramme-meters (0.14 foot-pound), or the work done in lifting 20 grammes to a height of one meter. When this energy is released, by the discharge of the antenna across the spark-gap, G, Fig. 26, part of this energy is expended in the heat of the spark and in heating the surface of the conducting antenna. The remainder is available for radiation as a series of electromagnetic waves. Perhaps not more than 3 gramme-meters (0.022 foot-pound) of energy will be shipped off in any single wave. Nevertheless, this energy is shot off by this particular antenna in $\frac{1}{2.5}$ part of a microsecond, and the average rate of power radiation during this brief interval will thus be 7,500,000 gram-meters per second, or 7,500 kilogramme-meters per second, or about 100 horse-power.

With the aid of auxiliary apparatus, an antenna may be capable of radiating electromagnetic wave

energy at the rate of hundreds of horse-power; but only for a few microseconds at a time, so that its average power in one second, or in one minute, during its operation, may be only a small fraction of a horse-power. An antenna of the simple type shown in Fig. 26, looks like a very simple and innocent machine; but, when thrown into electric vibrations, it may throw out as much power as it takes to operate a high-speed electric locomotive; only it does not keep the power up. The case is somewhat similar to that of a revolver, which is being fired, say, three times per second. At each explosion the power of the machine is relatively very great; but between shots the power falls to nil; so that the average for one second, the power of the machine, or its mean rate of throwing energy off, is comparatively low.

In practice, single-wire antennas are seldom used, and multiple-wire antennas are customary. The purpose of employing a plurality of conductors is two-fold. In the first place, the larger surface of the antenna gives more electric flux in the air when charged, and this increases the stock of energy held by the antenna prior to release and radiation. In the second place, the larger surface permits of a more free active radiation or discharge of electromagnetic waves into

the surrounding air, independently of the amount of energy to be released.

Cylindrical Antennas

Fig. 27 represents the cylindrical type of vertical antenna, one having four parallel vertical

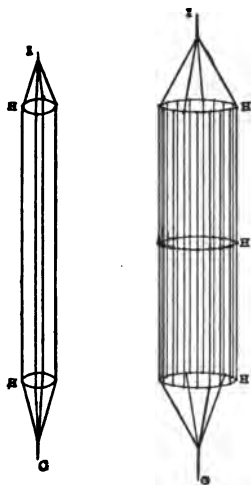

FIG. 27.—Types of Cylindrical Frame Vertical Oscillators.

wires and the other seventeen. Any convenient number may be used. The wires are usually soldered to two or more metallic hoops H H, which not only strengthen the structure mechanically, but also keep the oscillations symmetrical electrically. The diameter of these hoops may range from 30 centimeters to several meters (1 foot to several yards). If

the component vertical wires are not further than, say, half a meter apart (19.7 inches) these bird-cage cylinders are almost equivalent, electrically, to complete sheet-cylinders of metal. The bird-cage cylinder of multiple parallel wires is of course far superior

mechanically to a complete sheet-cylinder or large pipe, both in cost, lightness and freedom from wind-pressures. These cylindrical metallic frames may be supported by suitable insulators from a mast-arm at I, their lower extremities G leading to spark gaps.

In some instances a cylindrical antenna is formed of a rigid vertical steel tube, bolted together in sections and supported on insulators at the base. The tube or cylinder is prevented from falling by guy-ropes running in various directions, and in which insulators called strain-insulators, because they are subjected to tension, are inserted at some suitable point or points.

Harp, Fan and Inverted Cone Antennas

Other forms of antenna in use are outlined in Figs. 28 and 29. The former indicates the harp type. This is conveniently supported between two wooden masts, as indicated in dotted lines, but a single mast may serve if the wires are suspended from a horizontal arm. The five wires shown are connected at the top and at the bottom by horizontal wires. The entire conducting frame is supported by insulators at I I I I. The harp is connected to the spark-gap by the wire G.

The fan-shaped antenna of Fig. 29 is sometimes used on board ship. The stout wire I I is

strung between the masts B A and D C, being supported by end-insulators I I. The descend-

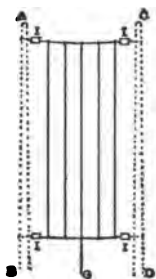

FIG. 28.

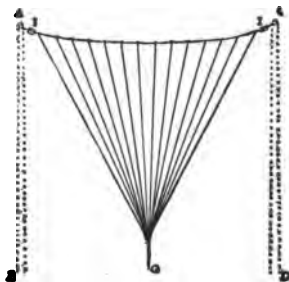

FIG. 29.

FIGS. 28 and 29.—Types of Harp-Shaped and Fan-Shaped Antennas.

ing wires are each connected to the top-wire I I above and to the central point below; whence a

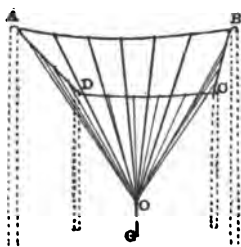

FIG. 30.—Type of Inverted Cone Antenna.

wire G runs to the spark-gap and ground, or on a steamer to the metallic frame of the hull.

At some stations a series of fans are connected together into an inverted cone, as seen in Fig. 30.

Here four masts support a metallic rectangle, through insulators not shown in the diagram. Metallic wires drop from the rectangle at inter-

vals to the central point O, whence a wire runs across a spark-gap to ground.

Whatever the form of the antenna, cylindrical, harp-shaped, fan-shaped or conical, the object sought, already mentioned, is to increase the electric flux, and electric energy associated therewith, in the charge of the antenna, and also to facilitate the emission of the waves into space at the recoils from the upper end or ends of the antenna.

Electric Oscillations on Antennas Skin Deep

The thickness of the individual wires forming the antenna is of secondary importance. It is the surface of the wires which is of principal consideration. The high-frequency electric currents, or oscillations, running up and down the antenna, are not able to penetrate below a certain skin depth into the conductor, say 1 mm. The higher the frequency, the less the penetration, and the thinner the effective conducting skin. The wires are usually of copper, and about 4 mm ($\frac{1}{8}$ inch) in diameter.

Other things being equal, the higher the antenna, of whatever form, the more electric flux, charge, and energy it will hold; so that the power it can release is greater. At the same time the length of the wave tends to be greater.

Sources of Energy for Feeding to an Antenna

The source of electric energy for charging the antenna is generally an induction coil, or spark coil, excited either by a dynamo, or by a voltaic battery. If a voltaic battery is used, it is commonly a secondary, or storage battery, charged by, and receiving energy from, a dynamo. Consequently, while it might be possible to use any electric source of energy, such for example as a frictional machine; yet, in practice, the energy is furnished by a dynamo driven by water-power, steam-power, or gas. An ideal form of dynamo exciter would be an *alternating-current* dynamo which generated to-and-fro electric currents, or currents of successively reversing directions, with a frequency precisely that required for setting up resonance in the antenna. If such a very high-frequency dynamo could be constructed conveniently, it would be capable of keeping the antenna in full oscillation indefinitely. That is, if the radiating power of the antenna were say 300 kilowatts or 400 horse-power, it would be possible to connect a dynamo of at least 300 kilowatts capacity (400 H P) to the antenna, and keep it constantly in action at that rate. Such a dynamo would have, however, to generate alternating currents with a frequency either of millions, or,

at least, many thousands of cycles per second; whereas the dynamos used in electric lighting and power transmission ordinarily only generate alternating currents with a frequency of sixty

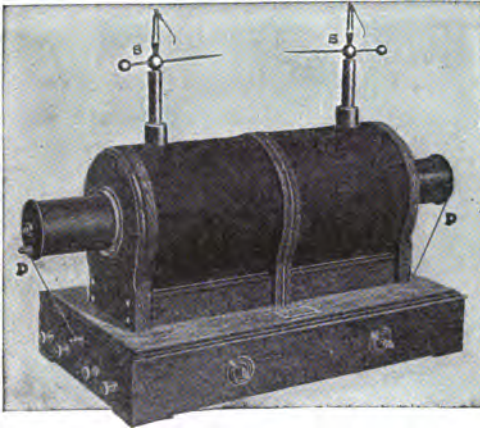

FIG. 31.—Induction Coil for Generating a High Voltage.

(60) cycles per second. This frequency is at least hundreds of times too low for direct excitation.

Under present conditions it is customary to charge the antenna by an induction coil of some kind. When the energy is supplied by a storage battery, an induction coil is used resembling that shown in Fig. 31. This apparatus, which is essentially a powerful spark-coil, has a central

core of iron, in the form of a bundle of iron wires. There are two coils, or windings, of insulated wire placed on the iron core. These two windings are carefully insulated from the core, and from each other. One is the primary winding, consisting of comparatively few turns of coarse cotton-covered copper wire. The other is the secondary winding of very many turns of fine silk-covered wire. The primary wires are led out at *p p* and the ends of the long fine secondary winding are connected to the discharge knobs *s s*. When a strong current is flowing steadily through the primary winding, supplied by an external storage battery, there will be no electric impulse, or *electromotive force*, in the secondary. There will, however, be a powerful stationary magnetic flux distribution surrounding the primary current, and linked with the secondary coil. If the primary current be now suddenly interrupted, the magnetic flux linked with the coils will collapse and disappear. In so doing, however, its movement generates a brief but very powerful electric impulse in the secondary winding, constituting a powerful electromotive force, or a high *voltage*, *i.e.*, a voltage capable of jumping across a considerable distance of air-space. Other things being equal, the length of the air-gap across which a spark will jump is an

indication of the magnitude of the electromotive force or voltage producing the spark.

Similarity of Process of Transferring Energy in Induction Coil to Wireless Transmission

The conditions which accompany the transmission of electric power from the primary to the secondary winding, a distance of a few millimeters or centimeters (a few tenths of an inch up to an inch or two), resemble those which accompany the transference of electric energy from the sending to the receiving antenna. Whereas, however, in the latter case, the distance between the primary and secondary wires is relatively very great, and the energy is transferred from one place to the other stowed away in a wave or series of waves; in the former case of the induction coil, the wave has no room to develop a separate existence, but the electromagnetic fluxes are linked with both circuits throughout the process. For the same reason, the efficiency of the transmission is enormously greater in the induction coil than in the wireless case. Nearly all of the electric energy leaving the primary winding is absorbed by the secondary winding. On the contrary, nearly all of the electric energy leaving the primary antenna goes off into space, or else is ultimately absorbed in the ground, and

hardly any is absorbed by the secondary antenna. In the rough calculation given on page 95, Chapter VIII, it appeared, for example, that only 1 part in 5,655,000 of the energy liberated by the oscillator, or sending antenna, was picked up by the receiving antenna, under the conditions there considered.

*Elements of Sending Apparatus for Producing
Electromagnetic Waves*

The elements of the connections at a wireless-telegraph sending station are illustrated in Fig. 32. AA is the antenna, or the wire connecting therewith. C is the induction coil. The primary circuit is marked in full lines and the secondary in broken lines. The primary circuit comprises the primary winding of the coil C, the voltaic battery B, a hand key K, and an electromagnetic vibrator or interrupter V. The vibrator may be a separate piece of apparatus included in the primary circuit; or it may form part of the induction-coil mechanism as shown. It is essentially a vibrating circuit-maker-and-breaker like the vibrator of the ordinary electric bell. Its purpose is to interrupt the primary circuit automatically and rhythmically, as long as the key K is depressed. The vibrator V may give interruptions at the rate of say 200 cycles per second.

It also gives a musical note or tone in the surrounding air, corresponding to its frequency of vibration. At each interruption of the primary circuit at the vibrator V, there is a sudden electric impulse generated in the secondary circuit,

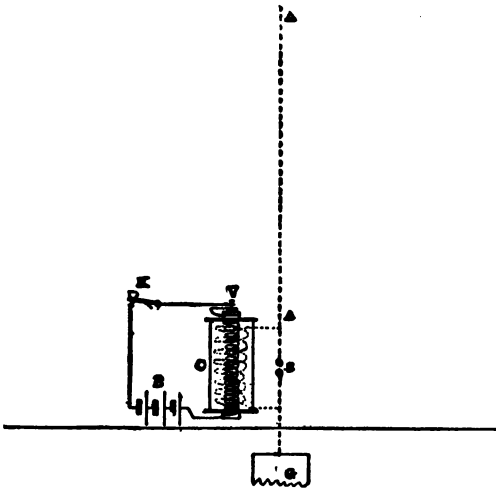

FIG. 32.—Elements of Connections at Sending Station.

and this travels up the antenna at light-speed. If the spark gap *g* did not break down, there would be a reflection of the impulse from the top of the antenna, accompanied by an electromagnetic impulse or radiation into space; but there would be no succession of waves and no

proper development of electromagnetic wave emission. If, however, the impulse on its return from the top of the antenna is able to break down the air-gap g in a spark discharge, the electric oscillation continues, and will go on in a succession of sparks, each feebler than its predecessor and each accompanying a half-wave of radiated energy thrown off into space. After a certain number

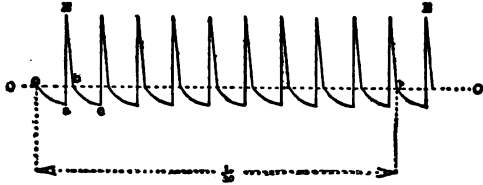

FIG. 33.—Diagram of Electric Impulses Delivered to Antenna by Induction Coil.

of sparks have passed, depending upon the length of the gap and other conditions, the impulse remaining is no longer able to follow up by another spark and the train of dwindling oscillations ceases. Fig. 33 shows diagrammatically the succession of electric impulses generated in the secondary coil under the action of the vibrator V , or at the rate which we have assumed to be 200 per second. The electromotive force rises to E with a sudden jump at each interruption of the vibrator, and then changes more slowly to a

smaller magnitude in the opposite direction. The sudden kicks *a E* are those which excite oscillations. Ten of these kicks are indicated in one-twentieth of a second. Each impulse occurs in one two-hundredth of a second, which is $\frac{5,000}{1,000,000}$ of a second or 5,000 microseconds.

Discontinuity of Electromagnetic Flashes from a Coil-Fed Antenna

Fig. 34 indicates the surges or oscillations set up in the antenna at every kick or impulse *a E*

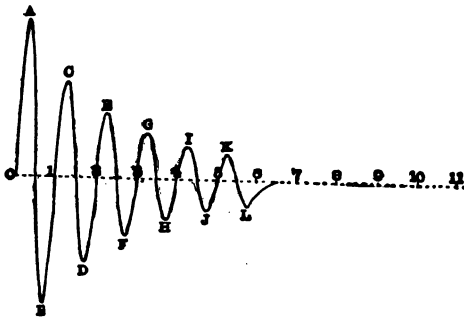

FIG. 34.—Diagram of Oscillations Set Up in the Antenna at Each Electric Impulse in Secondary Coil.

in Fig. 33, as set up by the vibrator *V* of Fig. 32. The illustrations show six complete waves *A, C, E, G, I, K* or twelve successively reversed impulses of steadily diminishing amplitude. The

last impulse L is supposed to be too feeble to create another spark at the gap g of Fig. 32, so that the series of oscillations comes to an end at L. Each complete or double oscillation is represented as occupying one microsecond, corresponding to an emitted wave-length of 300 meters (328 yards) or a height of simple rod oscillator equal to 75 meters (82 yards). It is evident that the whole series of six complete oscillations only lasts for 6 microseconds, and since the kicks, or stimuli, from the induction coil, only occur by assumption at intervals of 5,000 microseconds, there is evidently a long interval of darkness and inactivity between the little flashing intervals in which the antenna is giving out waves of invisible light, or long-wave polarized light. The period of darkness is in this instance 832 times as long as the period of light. If the key K in Fig. 32 were held steadily down, and the vibrator V were thus kept at work, a distant eye assumed capable of seeing this long-wave light would see the antenna shine out, in a certain unknown color, for 6 microseconds in every 5,000, like a flashing lighthouse which sent a beam over the sea for 6 seconds every eighty-three minutes. Although the numerical values here assumed may vary in practice through a considerable range, yet they are fairly represen-

tative, and a wireless telegraph sending antenna in full activity is many times more intermittent than the longest period flashing light house in the world.

The observer with the hypothetical eye capable of perceiving the long electromagnetic waves of wireless telegraphy would always see the flashes in the direction of, or "on the true bearing," as a sailor would say, of the sending antenna, but the flash would appear tangential to the surface of the ocean, or in the true level horizontal plane, as distinguished from the actual visible horizon which is depressed somewhat below; so that the observer would expect to see the luminous image of the antenna thrown up, as though by mirage, to the level of his eye or to the horizontal plane at his level. Long after the antenna ceased to be visible by ordinary short-wave light, which moves in radial straight lines, he would expect to see the flash of the antenna by the bending of the long waves around the conducting curved surface of the sea.

*Nature and Use of Auxiliary Condenser at
Sending Antenna*

An important piece of apparatus auxiliary to the antenna when set in oscillation is a

“condenser.” It consists of an expanded pair of opposed conducting surfaces, such as tin foil, separated by relatively thin sheets or intervals of insulating material, such as glass, mica, oiled paper, oil or compressed air. A simple condenser may be formed of a sheet of window glass, coated on each side with tin foil, except near the edges. The thinner the glass and the larger its surface area, the greater the electric charge it will hold, or the more electric flux and electric flux energy it will stow away in the glass, for a given magnitude of charging voltage, or in technical language, the greater becomes its *capacity*. Another well-known form of condenser is a glass bottle, coated on the inside, as well as on the outside, with tin foil. It is the glass walls of this bottle or Leyden jar, which receive the electric flux and flux energy when the jar is charged. The greater the surface of the jar and the thinner its wall, the greater will be its capacity.

Looking at an antenna as a condenser, or Leyden jar, the surface area of the conductor or conductors composing it may be considerable; but the slab of insulating air between the antenna and the ground is on the average many meters thick. Consequently, the capacity of an antenna is relatively small. An antenna 50 meters (54.7 yards) high, even if made up of numerous wires,

may have no more capacity than a single Leyden jar of ordinary size.

A diagrammatic view of the electric flux stowed away in the dielectric of a charged condenser is shown in Fig. 35, where the upper conducting plate is represented as being charged positively.

The flux density increases with the thinness of the insulating slab and also with the charging voltage. A limit to the thinness of the insulator is set, however, by the electric strength of the material, which ruptures, or breaks down in

spark discharge, if a certain electric intensity is exceeded. Air at an ordinary pressure and temperature has a strength (between parallel planes) of about 4 kilovolts (4,000 volts) per millimeter (101,600 volts per inch), glass 8 kilovolts per millimeter, mica 25 kilovolts per millimeter, and so on for other substances. The electric strengths are affected by the purity of the material, its temperature and other conditions.



FIG. 35.—Diagrammatic Section of a Charged Condenser Formed by Two Parallel Plates, Showing the Distribution of Electric Flux in the Insulator Between Them.

*Adjustment of Auxiliary Condenser Circuit to
Consonance with Antenna*

A condenser is often connected in parallel with the antenna at the sending station in the manner

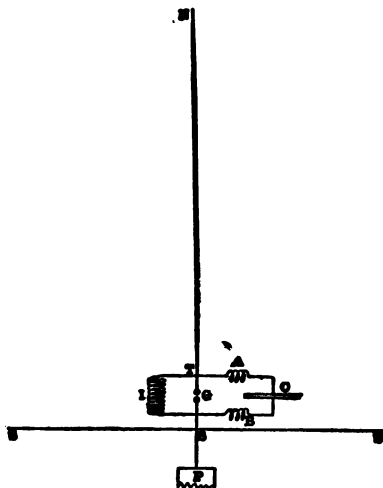

FIG. 36.—Condenser Connected in Parallel with Antenna to Re-enforce Oscillations.

indicated in Fig. 36. By this means the capacity of the insulated system may be much increased so that it will receive a much greater electric charge from the induction coil, with correspondingly increased electric flux and electric flux

energy. When the system of Fig. 36 is discharged at the spark-gap, the energy released in radiation may be considerably increased, owing to the presence of the condenser and its electric flux contents. On the other hand, however, the auxiliary circuit containing the condenser should be adjusted to the length of the antenna, in such a manner that the two shall oscillate together, or in synchronism. In other words, the time of oscillation of the condenser circuit A C B G should be adjusted to the time of oscillation of the antenna; otherwise, the oscillations of the two will mutually interfere, and cancel each other; so that if the condenser circuit is not tuned into synchronism with the antenna, the radiation into space may be weakened, instead of being enhanced, by the presence of the condenser, in spite of the greater stock of energy available.

The tuning of the condenser circuit may be accomplished not only by altering the size of the condenser, but also by altering the length and disposition of the wire connecting the condenser to the induction coil. If this wire be arranged in a coil A or B, Fig. 36, of several turns, the effect of the turns is to increase the virtual length of the wire in rapid proportion, because the magnetic flux generated around any one turn

links also, more or less, with the other turns. By suitably adjusting the number of turns of wire in the condenser circuit, the free period of oscillation discharge of the condenser can be adjusted into synchronism with that of the antenna; so that the latter can thereby be thrown into re-enforced oscillation and wave emission.

Loaded Antennas

It is also possible to alter the virtual length of the antenna, by connecting a coil of a few turns of wire in its circuit as indicated in Fig. 37. Such an antenna is called a *loaded* antenna to distinguish it from the simple or unloaded antenna of Fig. 26. An antenna loaded by a simple coil as in Fig. 37 always behaves as though its length were increased. That is its wave-length is increased, or its frequency of oscillation is reduced. Whereas, therefore, a simple antenna, say 25 meters (27.3 yards) in height, would throw off waves 100 meters (109.4 yards) long, or with a frequency of 3,000,000 cycles per second, or with a period of $\frac{1}{3}$ of a microsecond; the same antenna loaded with a coil might readily increase its wave-length to a kilometer or more (1094 yards) with a frequency of 300,000 cycles per second. At the same time, however, the radiating power of

the antenna, or the energy it can throw off in a single wave is likely to be greatly reduced by loading.

It is thus possible to adjust the antenna and the condenser into synchronism by altering the

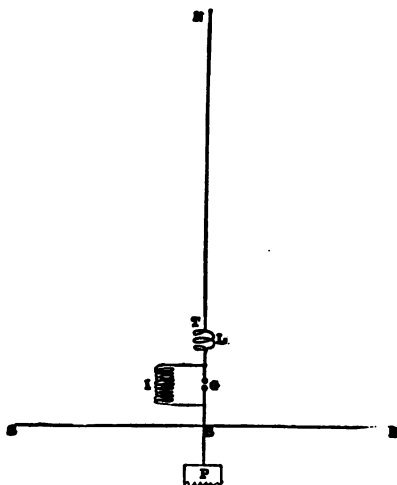

FIG. 37.—Coil Inserted in Series with Antenna to Increase Its Virtual Length.

number of turns of wire in circuit with either. It is also possible to lengthen the wave emitted by an antenna, within certain limits, by loading it with an appropriate coil, releasing the energy in a longer train of feebler waves instead of a very short train of stronger waves.

The length of the wave commonly employed in ordinary wireless telegraphy varies from say 100 meters to 10 kilometers (109 yards to 6.2 miles) corresponding to frequencies between 3,000,000 and 30,000. A common wave-length would be, say, 300 meters (328 yards) with a frequency of 1,000,000 cycles per second.

It may be observed that the presence of the induction coil I in Figs. 32, 36 or 37 does not appreciably affect the virtual length of the antenna, because it is in parallel to the spark-gap G and not in series therewith, like the coil L of Fig. 37. If the induction coil I were thrown in series, thereby adding its virtual length to the antenna, the frequency would be insignificantly low. On account of the very large number of turns in the secondary coil I, or, as it is technically expressed, on account of its large *self-induction*, the oscillations set up on the antenna pass across the gap G and are unable to find their way through the wire of the coil.

It is also possible to insert a condenser into the path of the vertical antenna with the tendency of increasing the frequency of oscillation, or of diminishing the virtual height of the antenna. The actions of a condenser and a coil are in this respect opposite to each other.

Danger of Secondary Internal Reflections Occurring in a Loaded Antenna.

When, however, any sudden obstacle or apparatus, such as a coil, a condenser, a resistance, or a discontinuity of any kind is inserted in the path of an antenna, there is a tendency to set up reflections of the oscillations at the discontinuity. These reflections may break up the rhythm and diminish the amplitude of oscillation. Consequently, care has to be taken so to introduce discontinuities into an antenna as to minimize the detrimental effect of internal partial reflection; or the benefit gained by the insertion of the discontinuity, as in adjusting the frequency to resonance, may be more than offset by the shattering of main oscillations into minor and discordant ripple trains.

CHAPTER X

ELECTROMAGNETIC WAVE-DETECTORS, OR WIRE- LESS TELEGRAPH RECEIVERS

Voltage Detectors and Current Detectors

SINCE the human eye is incapable of responding to the long-wave flashes, or electromagnetic waves, given off by a wireless telegraph antenna, an artificially constructed eye has to be used in order to detect and respond to them. The plan followed is to place an antenna at any suitable place in the path of the waves, so that oscillating electric impulses may be set up in this antenna, and then to permit these impulses to act upon some electromagnetic apparatus connected either directly in the path of the antenna, or indirectly, by the aid of a little induction coil. The receiving instrument must therefore be affected either by the oscillatory voltage, or by the oscillatory current in the antenna.

A voltage detector may be theoretically any apparatus which responds to electric potential difference; such as an electroscope or a pair of

diverging gold-leaves. In practice, however, it consists of a little instrument called a *coherer*.

A current detector may be of any of the various types which are used to indicate the presence of high-frequency alternating currents. There are a number of different receivers of which we need only consider the prominent types. In practice, there are three well-known types: namely, the *thermal*, the *electrolytic* and the *electromagnetic*.

Coherers

Coherers are illustrated typically in Figs. 38, 39 and 40. In Fig. 38, we have a sealed glass tube T T about 4 cms. ($1\frac{1}{2}$ inches) long and of $2\frac{1}{2}$ mm. ($\frac{1}{10}$ inch) bore. Near the middle of the tube are two metallic plugs, P P, often made of silver. These are connected to the external wires WW by sealed-in platinum connections. The plugs P P do not touch, but are separated by a small gap about $\frac{1}{2}$ mm. ($\frac{1}{50}$ th inch) wide. The tube may be partially exhausted of air; but the gap between the plugs P P contains fine metallic powder, or metallic dust, which lies loosely in the little crevasse.

The loose metallic particles bridging across between the plugs P P have the property of offering an obstruction, or very high resistance, to the flow of current from a single voltaic cell. In

other words, the gap is almost an insulator to this feeble voltaic electromotive force. If, however, a higher electromotive force be applied across the gap for even a very minute interval of time, its effect is to break down the insulator and



FIG. 38.



FIG. 40.



FIG. 41.

FIGS. 38, 40 and 41.—Types of Coherers.

to allow the voltaic cell to send a continuous current. The sudden higher electric impulse changes the resistance offered by the bridge of metallic dust from a very high to a relatively low value.

The exact nature of the action which takes place when the electric impulse operates, and

when the resistance of the gap breaks down, is hard to determine with certainty. It has been much discussed and unanimity has not yet been reached upon the matter. It suffices for present purposes, however, to say that the extra voltage brought to bear across the gap of metallic particles causes them to weld together, or to *cohere* electrically, thus converting a very bad joint in the local circuit of the voltaic cell into a fairly good one.

Connections Between Coherer and Antenna

The simplest method of connecting the coherer of Fig. 38 with the receiving antenna is indicated in Fig. 39. A B C S G is the antenna path to ground. It is cut at C, and the coherer inserted by means of the wires W W, Fig. 38. A *local circuit* E M C, indicated in broken lines, connects a suitable low voltaic electromotive force, such as a single voltaic cell, to the coherer terminals through an electromagnetic receiver, represented as an ordinary wire-telegraph sounder. Prior to the arrival of electromagnetic waves, the gap of filings in the coherer interposes a high resistance in the local circuit, as well as in the antenna path. Consequently, no appreciable current flows through the sounder M, the armature lever of which remains released against its

upper stop under the action of a spiral spring. As soon as an electromagnetic wave, or wave-train, of suitable intensity passes the antenna, an oscillating electromotive force will be set up along the antenna and across the coherer gap. The

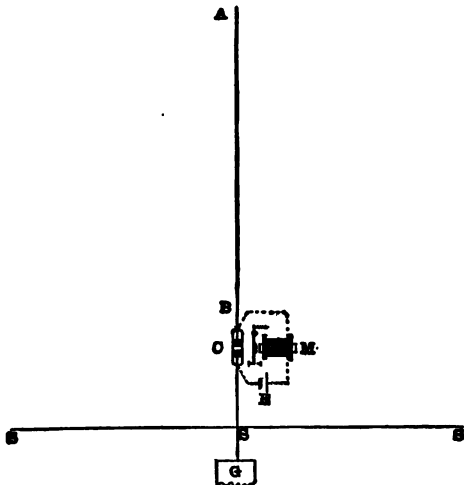

FIG. 39.—Essential Elements of Coherer Connections When Receiving Signals.

coherer will instantly break down in insulation, and will cause the metallic filings to cohere. The oscillations will not discharge through the local circuit owing to the self-induction or choking effect of the coil on the magnet *M*. The voltaic cell *E* will now be able to send a current through

the local circuit E M C and excite the electromagnet M of the sounder, the armature lever of which will descend with a click, thus giving evidence of the arrival of the wave.

Mechanical Decoherence

The current in the local circuit would continue indefinitely after the bridging of the coherer gap by the first wave, if means were not provided for *decohering*, or restoring the coherer to its original insulating state. This may be done by giving a tap or light mechanical agitation to the coherer tube, thus shaking up the filings in the gap and breaking up the recently welded bridge between the plugs P P, Fig. 38. In practice, the armature lever of the sounder M, may be arranged to deliver a light tap to the coherer tube at the same moment that it produces its click. This tap restores the original condition of the coherer, interrupts the local circuit and cuts off the excitation from the sounder magnet M, which promptly releases its armature lever under the influence of the spiral spring; so that the apparatus is again ready to respond to the next electromagnetic wave.

The connections of the local circuit are usually somewhat more complex than Fig. 39 shows; but the principle remains essentially the same.

The sounder M, for instance, is not directly actuated by the local circuit of the coherer, because it needs a relatively strong current, which is unsuitable. A delicate electromagnet called a *relay* (see Figs. 60 and 61) is, however, placed in the circuit at the point M, and the armature lever of the relay closes another local circuit through a more powerful voltaic battery and the sounder. A feeble current through the local circuit of the coherer is thus enabled to send a suitably strong current through the sounder. An auxiliary electromagnet, actuated also by the relay, is often applied to the sole duty of tapping the coherer, or causing it to decohere, after the relay and sounder have responded.

It is evident that when the apparatus is in working order, signals consisting of short and long groups of electromagnetic waves will be able to spell out corresponding short and long operations of the electromagnet M, or dots and dashes of the Morse alphabet.

Fig. 40 represents a modified form of coherer in which there are two gaps g g. In each gap there is a little globule of mercury. The end plugs C C may be of carbon, and the central plug a little cylinder of iron. This form of coherer has the advantage that it is self-decohering, or auto-decohering. That is to say it needs no

blow or agitation to restore the *status quo* after the passage of a wave. It normally possesses a high resistance. The electric oscillation or surge in the antenna breaks down this resistance momentarily and permits a current to flow through a local voltaic circuit. Immediately after the passage of the wave the high internal resistance is restored. The reason for this remarkable action is concealed in the general obscurity of the whole subject of coherence, but is perhaps connected with the liquid state of the substance in the gaps.

Another form of coherer is indicated in Fig. 41. It consists of a small insulating vessel or reservoir V, containing mercury. The mercury is brought into very light contact with the thin edge of a metallic disk P, kept rotating by clockwork. There is a very thin film of insulating oil on the surface of the mercury and the effect of the film is to insulate, or electrically separate, the metallic disk from the mercury. The thin film, may, however, be broken down, or electrically disrupted, by a relatively feeble voltage in excess of that used in a local voltaic circuit. The wires W W connect the device with the local circuit and the antenna, as in Fig. 39. On the arrival of a signal, the oil film is broken and contact established between the disk and mercury; but

the revolution of the disk almost instantly restores the oil film and decoheres the device.

Hot-wire Receivers

Coherers depend, as we have seen, upon the electromotive force or voltage of the surge set up in the antenna to force a discharge across the gap

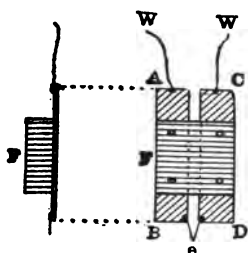

FIG. 42.—Hot-Wire Receiver.

of imperfectly contacting matter, in order to give passage to a local voltaic current. Among receivers which depend, however, upon the magnitude of oscillating current set up through them when they are inserted in the path of the receiving antenna, without interrupting the same, we have the hot-wire receiver.

One form of this device is presented to view in Fig. 42. A pair of parallel brass strips AB, CD, are fastened near to each other and side by side, by an insulating block F of hard rubber. Leading-in wires W W are soldered to these strips above, at A and C. Between the lower adjacent corners is soldered a little piece of silver wire e, bent into the form of a sharp V. This silver wire may be about 3 millimeters (0.12 inch) long and about

0.076 millimeter (0.003 inch) in diameter. A cross section of this silver wire is indicated in Fig. 43, at A B C. At or near the center *q* is a thin filamentary wire of platinum, like the wick inside a paraffin candle.



FIG. 43.—Cross-Section of Composite Wire.

The diameter of the platinum wick is about 1.5 microns (0.0015 millimeter or 0.000,06 inch), or about one-fortieth of the diameter of a thin human hair. A platinum wire so fine is only obtained by thickly coating an ordinary size of platinum wire with silver, and then drawing down the thick composite wire

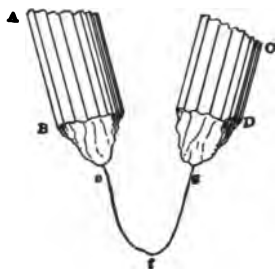

FIG. 44.—View of Loop of Sensitive Fine Wire Under Microscope.

through successively diminishing dies. As the silver wire gets thinner and longer, so also does the internally held wick or filament of platinum. After the little V loop of silver candle-wire has been soldered to the brass plates at B and D, Fig. 42, the device is carefully lowered into a bath of nitric acid, in such a manner that the point of the V loop is submerged in the acid, which immediately attacks and dissolves the sil-

ver chemically, leaving the platinum wick uninjured. The process is aided by a feeble electric current from a local voltaic cell, is watched under the microscope, and is arrested at the proper stage. The appearance in the microscope of the V loop after the silver has been dissolved off the tip is shown in Fig. 44, where A B and C D are the 76-micron or 0.076 millimeter silver wires, and e f g the 1.5 micron platinum filament, hanging in a short loop. The device is then ready for use and is conveniently protected from injury by placing it in a short glass bottle or test-tube.

The connection of the little hot-wire device with the receiving antenna is illustrated in its simplest elements at Fig. 45. A B is the antenna, connected to ground through the hot-wire at H. A local voltaic circuit, in broken lines, connects a feeble electromotive force, such as a single voltaic cell, through the telephone receiver T and the hot-wire H. Prior to the advent of electromagnetic waves, a steady current flows through the local voltaic circuit, producing no sound in the receiver T. This current serves to warm the fine platinum wire, the electric resistance of which is appreciable, but constant at any constant temperature. As the temperature of the platinum is increased, however, the resistance increases.

If now an electromagnetic wave or wave-train strikes the antenna B A, an oscillating current will pass through the fine platinum filament H, and will heat the same appreciably, being superposed upon the steady current from the voltaic

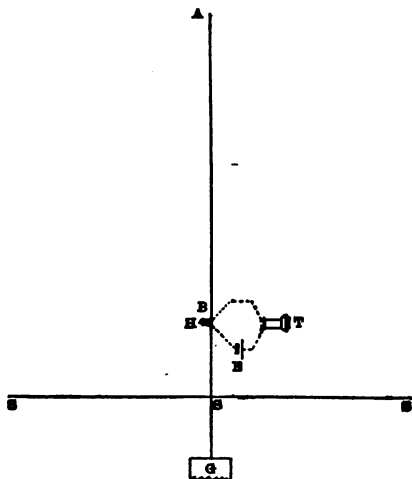

FIG. 45.—Connection of Hot-Wire Receiver with Receiving Antenna.

cell E. The antenna is prevented from discharging to ground through the telephone T; or by the path AB TE SG, owing to the self-induction, or choking effect, of the telephone. Practically all the discharge goes through H. The momentary increase in the heat and tem-

perature of the filament H causes its resistance to be momentarily raised, and this reacts upon the local voltaic current, diminishing the same momentarily. The telephone T responds audibly to the sudden alteration of current, which lasts as long as the waves or groups of waves are passing, and ceases the moment the waves cease to arrive. The sensitiveness of the device is due to the small dimensions of the fine filament. The oscillating electric currents received through the filament from the antenna are very feeble when the antenna is far from the sending station; but the cross-section of the filament being only about 2 square microns ($\frac{1}{5000}$ of one millionth of a square inch), even a very feeble electric current will be condensed to a relatively appreciable current density at the filament, thus giving rise to appreciable heating in a mass of metal only about 2,000 cubic microns in volume ($\frac{1}{5000}$ th of one millionth of a cubic inch).

Electrolytic Receivers

The device, represented in outline by Fig. 46, consists of a small vessel C containing a suitable solution, such as dilute nitric acid. A candle wire w, of the kind above described in connection with Figs. 43 and 44; *i.e.*, a silver wire of about 76 microns in diameter (0.003 inch) with a

platinum wick about 1.5 microns in diameter (0.000,06 inch), is immersed to a suitable depth, perhaps a quarter millimeter (0.01 inch) in the solution. The acid dissolves off the silver, so that the filament of platinum is immersed in the solution, offering thereto an immersed surface area of about 1,200 square microns ($\frac{1}{2,000,000}$ th of a square inch). The wire *w* is fastened to the lower end of a brass screw having a milled head *ss*, the screw passing through a brass support *P P*. The depth of immersion of the fine platinum filament can be adjusted by turning the milled head in one or the other direction.

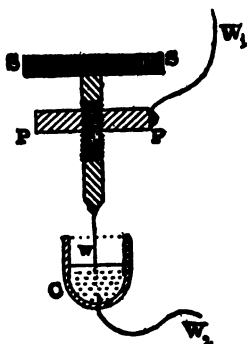

FIG. 46.—Electrolytic Receiver.

A solution of an acid or alkali traversed by an electric current is called an *electrolyte*, and the current is carried only by atoms, or groups of atoms, which are separated out from the solution. In other words electric conduction through an electrolyte is accompanied by chemical decomposition of the electrolyte.

The connection of the electrolytic receiver with the receiving antenna is essentially the same as

that of the hot-wire receiver represented in Fig. 45. That is, a local voltaic current is provided containing a small electromotive force and a telephone receiver. Prior to the advent of the electromagnetic waves, the cell E, Fig. 45, sends a feeble steady current through the telephone and the electrolytic receiver. This current causes minute bubbles of gas to be liberated from the fine immersed platinum filament, but the telephone T gives no sound. As soon as an electromagnetic wave strikes the antenna, the oscillating current set up passes through the electrolytic receiver, and heats the same in the minute constricted mass of liquid immediately surrounding the fine platinum filament. The effect of the heat so liberated is two-fold. In the first place it momentarily raises the temperature of the pellicle of solution immediately surrounding the filament, thereby reducing the electric resistance of the device; for electrolytes, unlike metals, improve in conductivity when heated. In the second place the gas is liberated more freely from the surface of the fine filament as the temperature is increased. In technical language, the momentary warming effect of the oscillating current causes the filament to be partly *depolarized*. Owing to both of these actions, the apparent resistance offered to the local current from

the voltaic cell is temporarily diminished and the sudden increase of current produces a sound in the telephone. Immediately after the passage of the wave, the heat is dissipated by conduction into the solution, and the original resistance and *counter electromotive force of polarization* in the device are restored.

The sensitiveness of this device is attributable to the constriction of the conducting path from antenna to ground into a minute volume of liquid, having an extremely small cross-section. In this tiny volume there exists a very appreciable electric resistance and also an appreciable electrolytic back voltage, like that of an opposing voltaic cell. The thermal effects of even a very feeble oscillating current from the antenna are here condensed into so small a volume that the temperature of that small volume can be appreciably raised. The rise of temperature has a powerful effect both on the localized resistance of the constricted liquid path and on the back voltage of the virtual opposing voltaic cell contained in the device.

Another form of the electrolytic receiver is represented in Fig. 47. A vessel, V V V, such as a small glass tumbler, is filled with an electrolyte such as dilute nitric acid, or dilute caustic soda, to the level L L. Two metallic surfaces

or *electrodes* dip into the electrolyte. One of these, indicated at E, may have any convenient size and shape, connecting with a leading-in wire W_2 ; or this wire may itself dip into the solution and form the electrode E. The other

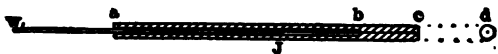
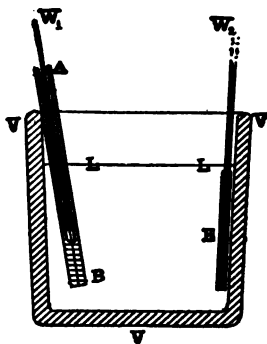

FIG. 47.—Simple Form of Electrolytic Receiver.

electrode like w , in Fig. 46, has extremely small surface area. A very simple way of preparing such a small area of electrode is illustrated in greater detail at the lower part of the Figure. A glass tube, $a\ b\ c$ of any convenient dimensions, say 7.5 cms. (3 inches) long, 3 mm. and 1 mm. (about $\frac{1}{8}$ and $\frac{1}{25}$ inch) in external and internal

diameters respectively, is slipped over a short length of copper wire. This copper wire is welded at one end in the flame of a Bunsen burner to a few centimeters (one inch, say) of fine platinum wire having a diameter of about 0.05 mm. (0.002 inch). In the illustration, the weld or junction between the copper and platinum wires is shown at J. The tube is then heated to the softening point over the fine platinum wire, and the softened walls are squeezed tightly over the platinum wire with a small pair of tongs, so as to seal in the wire hermetically for a short distance, say 1 cm. ($\frac{3}{8}$ inch). The tube after cooling is now scratched with a file across the seal and is broken sharply across with the fingers. The break if properly made will leave the ruptured platinum wire very slightly projecting beyond the glass. A few strokes, with a fine file, will file the platinum wire flush with the glass, thus presenting as at *d*, Fig. 47, an exposed disk of platinum of the diameter of the fine wire at the end of the seal *b c*, and with a surface area of about 2,000 square microns or $\frac{2}{1,000,000}$ square inch.

The depth of immersion of the glass tube in the electrolyte is of no consequence so long as the end of the fine platinum wire is fairly covered by the solution. Neither does the distance between

the two electrodes in the vessel V V, make any appreciable difference. In other words, the seat of the actions occurring in the apparatus is in the constricted liquid path immediately covering and including the minute exposed area. The resistance of the device is practically all located within a millimeter ($\frac{1}{25}$ inch) of the exposure, and the voltaic counter electromotive force of polarization is located at the exposure; so that all the rest of the electrolyte merely provides an outward escape for the electric current that has passed through the intensely constricted region of influence over the minute area.

This form of electrolytic receiver is probably the simplest to construct of all the receivers used in wireless telegraphy. Like most of the other devices it is patented. It is not capable of adjustment in surface exposure area, like the apparatus of Fig. 46, and if the minute exposure gets dirty or clogged, it has to be thrown away and a new one substituted. It is, however, capable of great sensitiveness and the materials for its construction are very easily obtained.

Electromagnetic Receivers

There are various types of electromagnetic receivers, but that illustrated in Fig. 48 is generally admitted to be the most sensitive. It con-

sists of a flexible band *b b b b* of iron wires passing over the grooved pulleys *L L*, which are steadily driven by clockwork. The band of iron wires moves through a glass tube *t t*, on which is placed a winding of insulated wire with external connections *W W*, leading to the antenna on one side and to ground on the other. This winding,

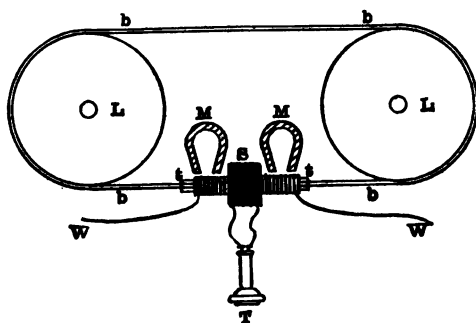

FIG. 48.—Magnetic Receiver.

inserted in the antenna path, forms the primary winding of a little induction coil, in which the moving band of iron wires is the core. The secondary winding *S*, placed over the middle of the glass tube is connected to a telephone receiver, *T*.

The band of iron wires in passing through the tube makes its procession in front of the two fixed permanent horseshoe magnets *M M*. These

are so arranged with regard to strength and direction of polarity, that the band of iron emerges from the tube with its internal magnetism reversed in direction from that with which it enters.

Iron has a curious magnetic property when its magnetism is cyclically reversed. If the magnetism is established along a band of iron wires in one direction, then when the process of demagnetization and reversal is started, the change of magnetic flux in the iron takes place very slowly at first, until a certain stage of magnetic instability is reached, and then the magnetic flux reverses with great swiftness. The action may be compared to that of a ball moving alternately from side to side on the deck of a rolling ship at sea. If the deck is flat and plane, the ball will swing regularly from side to side. If, however, the deck be somewhat bowed, rising in the middle like a turtle-back, the ball will be slow to return on each roll until it gets to the top of the turtle-back and then it will run down with great speed.

The function of the two magnets M M in the magnetic receiver is to bring the iron wire core of the induction coil into the unstable magnetic condition during its passage within the primary winding connected in the antenna path. Under these conditions, if any electric oscillations come

through the primary coil from the antenna, they will be able to shake out the magnetic flux in the enclosed band and precipitate its reversal. The rotating mechanism brings the magnetic flux to the edge of the precipice, as it were, and the feeble electric currents are able to push it over. The sudden change of magnetic flux inside the secondary coil *s*, sets up an electric impulse that will produce an audible sound in the telephone *T*.

The above form of magnetic receiver is thus essentially an induction coil with the antenna path passing through the primary winding and the delicate receiving telephone in the secondary. The induction is increased in sensitiveness by the aid of the constantly renewed magnetic instability in the iron core, under the action of the permanent magnets.

Comparison of Receivers

Comparing the behavior of the various types of receiver, it is to be noted that the coherer is the only one which permits of a permanent record being obtained. The coherer, as outlined in Fig. 39, operates an electromagnetic receiver of the Morse type. Such a receiver is able to record the message in dots and dashes inked upon the surface of a long strip of paper, coiled on a roller in the apparatus and moved by clockwork. A

particular form of Morse inkwriter is seen in Fig. 49. It will be observed that the armature consists of a split soft iron tube fastened to a rocking lever in such a manner as to be attracted downward when the black coated electromagnet

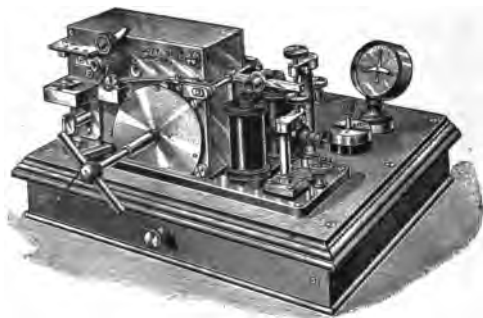

FIG. 49.—Morse Inkwriter.

is excited. The lever throws up a disk against a moving band of paper not shown. The disk is kept rotating by clockwork and dips into an inkwell.

On the other hand, however, the speed at which signals can be received and recorded by means of the coherer is distinctly lower than that obtainable with non-recording receivers. A speed of 15 to 20 words a minute is considered good with a recording receiver. With some non-recording receivers this speed may be doubled.

In regard to sensitiveness, the coherer has hitherto proved much inferior to the others. The most sensitive is the electrolytic receiver and next to that the magnetic. Both of these use the telephone as the receiving instrument.

Telephone Receivers

A convenient form of telephone receiver, illustrated by Fig. 50, is such as telephone operators employ. A leather-covered steel band L L goes over the head and supports the receiver R R close to one ear. The band is fastened to the receiver by the thumb-screw s. The covered wires w w serve to connect the receiver with the antenna system.



FIG. 50.—Head Telephone.

Fig. 51 shows the parts of the receiver disassembled. B B is a hard rubber box with a screw cover C. Inside the box are three pairs of half-ring steel permanent magnets, NS, NS. In the center, a pair of soft iron pole pieces are supported, receiving their polarity from the magnets NS and wound with many turns of fine silk-covered copper wire connecting with the leading wires *ww*. D is the ferro-type disk of steel

which is clamped around its edge between the box and the cover, so as to be held over but not quite touching the poles at the center.

The sensitiveness of the electrolytic and magnetic receivers is at least partly attributable to

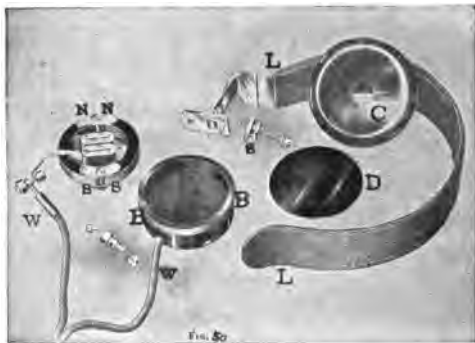

FIG. 51.—Head Telephone Disassembled.

the great sensitiveness of the telephone which they employ as their intermediary with the human brain. The telephone, as is well known, is extraordinarily sensitive in detecting feeble electric currents undergoing rapid variation.

CHAPTER XI

WIRELESS TELEGRAPH WORKING

Alternate Use of an Antenna for Sending and Receiving

IN order to carry on simple wireless telegraphy between a single pair of stations, remote from all other wireless telegraphists, it is evidently necessary to have an antenna at each station. The dimensions required for the antennas will depend upon the distance between them. For sending messages from one room to another in the same building, the antennas may be a few centimeters or inches long. For sending messages between adjacent buildings, or buildings separated only by a few kilometers or miles, the antennas need only be a few meters or yards high. For distances of hundreds of kilometers or miles, large and tall antennas are at present necessary. The object of the sending station in long-distance wireless telegraphy is to throw out as long a train of powerful waves as possible, while that of the receiving station is to employ as sensitive a receiver as possible.

One and the same antenna is used at a station for sending and receiving alternately. The connection is changed from the sending to the receiving apparatus by a switch as indicated in Fig. 52.

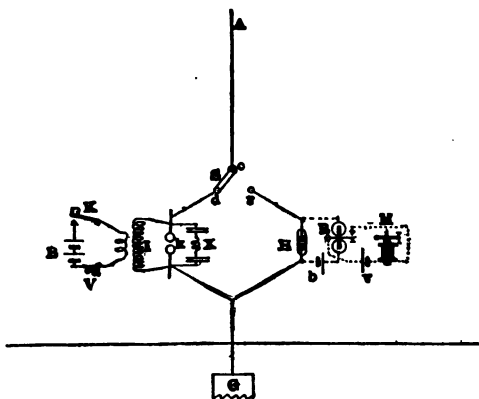

FIG. 52.—Diagram of Switch Connections from Sending to Receiving.

The switch *S*, has a metallic blade or lever-arm which is pivoted at *c* and may be turned into contact with the point *d* for sending, or with the point *r* for receiving. *A* is the antenna, or the wire leading thereto, and *G* the ground-connection. In the position shown, the switch is turned to the sending position and the antenna is connected to the spark-gap *k*. This is excited by the induction-coil *I* and vibrator *V*, when the

key *K* in the primary circuit is depressed. There is also an auxiliary circuit *X*, consisting in this case of a pair of condensers with a coil between them, to increase the stock of radiation-energy prior to discharge. The receiving apparatus is indicated as consisting of a coherer *H*, working into a relay *R*, (see Fig. 61) through the local circuit *H R b*. The relay in its turn operates the sounder *M* through a second local circuit, including the voltaic cell *v*. It is necessary to make sure that the delicate receiving apparatus is completely disconnected from the antenna while the latter is being used for sending. Sometimes an automatic switch is used which will not permit the induction coil to be excited unless the receiver is cut off. In some installations the coherer and its immediate connections are shut up in a metal box to keep accidental waves from impinging upon the coherer.

The sending key used in wireless telegraphy differs only in mechanical details from the ordinary Morse key of wire telegraphy. An ordinary Morse key is illustrated in Fig. 53, and a form of wireless telegraph key in Fig. 54. The wireless key has to send a much stronger current to the induction coil than that which an ordinary wire-telegraph key controls, so its contact is larger and stouter. Moreover, there is a pos-

sibility of the operator receiving a severe electric shock from the induction coil; so the insulating handle is made more massive. There is apt to be some sparking at the key contact on breaking



FIG. 53.—Ordinary Wire-Telegraph Morse Key.

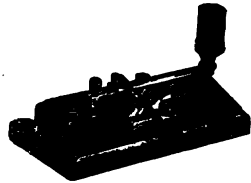

FIG. 54.—Form of Wireless-Telegraph Morse Key.

circuit, and certain forms of key are designed to overcome this, in some cases by breaking the contact under oil, and in others by breaking the contact between the poles of an electromagnet.

. Morse Alphabets or Codes

In sending signals, the contacts of the key are made by the operator in conformity with the Morse code. There are unfortunately two telegraph codes—the American Morse code, or that in almost universal use on the North American continent, and the international Morse code, or continental Morse code, in use in practically all other parts of the world. The American Morse code was introduced in the early days of the Morse system in the United States. In Europe,

about the same time, a number of different alphabets or codes sprang into existence, in different places. The frequent transition and intercommunication of messages among European countries was soon hampered by differences in Morse alphabet, so that, by international convention, the present Continental code was arrived at and adopted. Unfortunately, the date of this convention was prior to the introduction of Atlantic cables and fast ocean steamers so that America was not a party to the conference.

The two codes are presented in Fig. 55, so far as concerns the use of the English language. It will be seen that the signals for a, b, d, e, g, h, i, k, m, n, s, t, u, v, w, and 4 are common to both codes; while the signals for c, f, j, l, o, p, q, r, x, y, z, 1, 2, 3, 5, 6, 7, 8, 9, 0, ., ?, and ! are different. In both codes the dot is the standard element of length. A dash has the length of three dots, and the space separating dots or dashes in a letter are of dot length; except in the American letters c, o, and z which are called *spaced* letters, and in which there is an extra space of two dots' length. The American l is a six-dot length dash, and the American zero is a nine-dot length dash. The space separating adjacent letters is three dots long and the space separating words, six dots long.

The American code is shorter on the average, in the signaling of ordinary English, by about 5 per cent.; that is to say 95 dot elements of American code will be equivalent in the formation of letters to 100 elements of international code, so that the American code is swifter by about this amount. On the other hand, the spaced American letters are a source of possible errors, if the signaling is not in the best condition, and some operators who are practically acquainted with both codes maintain that, owing to the care needed in sending spaced letters, there is no sensible difference in swiftness between the codes. It is certain that a person conversant solely with one of these codes is quite unable to read messages sent in the other. Listening to the other code in such a case is like listening to foreign unknown speech. It is greatly to be regretted that this confusion of telegraphic language exists, and wireless telegraphy has tended to make the confusion more evident. Most of the ships carrying wireless telegraph outfits talk international Morse. Only those like the Fall River Liners, on the American coast, talk American. Some ships can talk in either code.

Each dot contact of the sending key must be accompanied by at least one discharge of the induction coil and, therefore, by at least one

Continental		American	Continental		American
A	---		W	---	
B	----		X	----	----
C	----		Y	----	----
D		----	Z	----	----
E	-		1	----	----
F	----		2	----	----
G		----	3	----	----
H	----		4		----
I	--		5	----	----
J	----		6	----	----
K		----	7	----	----
L	----		8	----	----
M		----	9	----	----
N	--		0	----	----
O	----		.	----	----
P	----	----	?	----	----
Q	----	----	!	----	----
R	----		sn	----	----
S	----		,		----
T	-		;		----
U	----		:		----
V	----		&		----

FIG. 55.—Continental and American Morse Telegraph Codes.

spark, or train of oscillating spark discharges at the spark-gap k , Fig. 52. The dashes, on the other hand, need to set up a series of discharges. A dot may thus be accompanied by a single interruption at the vibrator and a dash by three or more such interruptions.

Alternations of Sending and Receiving.

During the time that the message is being sent, the operator is unable in the ordinary wireless system to receive a message, or to know whether the receiving operator has been able to take the signals. In ordinary wire telegraphy, as practiced in the United States, the receiving operator can "break" the line circuit, and thus notify the sender that the message is not being taken. But the receiver of a wireless telegraph message cannot ordinarily stop the sender, and the sender goes on until either the message has been concluded, or until he deems it prudent to turn his switch and let the receiver send back encouragement to proceed. For the same reasons, it is not uncommon for the sender to repeat a message, as soon as he has finished it, in order that the distant receiving operator may check what he has written against the repetition, so as to avoid mistakes. Attempts have already been made to send and receive messages simultaneously by the

same antenna, but such operations can only be regarded at present as in a subsidiary stage. As soon as the difficulties in the path of ordinary, simple, simplex to-and-fro wireless telegraph signaling have been overcome, it will be time to attend to the development of more intricate methods.

The Insulation of Antennas

The insulator or insulators which support the sending antenna have to be maintained in good order, because they must withstand high voltage without appreciably leaking or sparking. Wherever the antenna wire or wires come in contact with any substance, an insulator has to be used, especially where there is a chance of moisture from rain, dew or fog. The antenna may itself be an insulated or rubber-covered wire. This is, however, of but little service except in preventing atmospheric discharges from driving wind and snow. On the other hand, the insulation of an antenna used solely for receiving messages need not be so carefully maintained. In order to send messages, powerful voltages must be used and insulated; but in order merely to receive messages, or to listen to what is going on in the neighboring ether so far as concerns long electromagnetic waves, only feeble voltages are pro-

duced; so that while insulation is proper, it need not be safeguarded elaborately. A bare copper wire fastened around a branch of a tree and touching the boughs or trunk at several places on the way down, may often enable messages to be received. Such a wire could hardly be used for sending messages to a distance.

Heights of Antennas

Antennas are carried to various heights, as already mentioned. Since the trouble and expense of construction increase rapidly above a height of 30 meters (32.8 yards), very high masts are only installed for very long distance transmission. The greatest height to which they have been thus far carried is 128 meters (420 feet), in the form of a steel chimney. On board ship the mast height usually limits the elevation of the antenna to about 30 meters (98.4 feet). A widely extending antenna is not so useful for receiving as for sending, except when the waves are much longer than four times the mast height; because although side expansion no doubt affords an increase of catchment area for passing waves, there is little doubt that the area from which energy is absorbed by a receiving antenna is fairly wide (see page 84), even when the antenna consists of but a single vertical wire. On the

other hand, increasing the height of a receiving antenna increases the energy that can be scooped out of a passing wave-train approximately as the square of the elevation, provided that resonance is maintained; so that increase of height always aids long-distance reception.

The ordinary height of a shore antenna mast is about 45 meters or 150 feet. If a mast is observed on the seashore with a little wooden house at the base, it is highly probable that it is constructed for wireless telegraph purposes. If a group of several wires can be seen to festoon from the masthead to the house, the existence, either in the present or past, of a wireless telegraph station may safely be assumed.

Although the usual method of installing an antenna is to have the same insulated at the top and well grounded at the base, yet other methods are possible and are occasionally employed. For example, the antenna may consist of an arch or vertical loop, either one or both ends of which may be grounded. Again, the ground connection of an antenna may be dispensed with entirely, and an insulated metallic plate used in its place, the plate being preferably supported parallel to the ground and at a height of about 2 meters (6.5 feet) above it. Such a plate is equivalent to an air condenser inserted in the

antenna path near the ground connection. Or, the ground may be dispensed with, and a horizontal wire may be run at a short distance above the ground. A number of such variations of installation have been suggested or used at different times; but while they introduce differences of action in detail, they usually conform to the same broad, fundamental principles of action as the ordinary lightning-rod type of vertical wire antenna with grounded base.

*Power Required for a Wireless Telegraph
Sending Station*

In order to receive wireless signals, no power has to be expended beyond the almost infinitesimal amount supplied by voltaic cells in the local circuit or circuits of the receiver. But in order to transmit signals to a distance, very appreciable power must be supplied. For distances under 100 kilometers (60 miles), the power supplied does not usually exceed 3 kilowatts (4 horse-power), and is sometimes considerably less. As the distance increases, the power absorbed is likewise increased. A few stations use 50 kilowatts (67 horse-power) or more. As we have already seen, the antenna radiates the power by jerks, or with long intermissions; so that although in sending with the key depressed, the

power supplied to the primary winding of the induction coil may be; say, 2 kilowatts ($2\frac{2}{3}$ horse-power), the antenna may be varying in power between 200 kilowatts and 0.

In the neighborhood of a city, or of an electric lighting system, the power required may be taken from electric-light mains. The same facility may be afforded on vessels electrically lighted. Otherwise, a small gas, oil or steam-engine has to be installed, in order to generate the power required.

Contrast Between Power Required for Wire and Wireless Telegraphy

The contrast between wire and wireless telegraphy is nowhere more marked than in respect to power. In wire telegraphy, over a distance of, say, 200 kilometers (120 miles), the power required for the transmission of messages is perhaps 8 watts at the generator (5.9 foot-pounds per second, or 0.0107 horse-power). In wireless telegraphy, working over the same distance, 8 kilowatts (10.8 horse-power) may be expended, or a thousand times more. Even then, the wireless system is only rendered practicable by the enormously greater sensitiveness of the receiving apparatus it employs. In the one case, the electromagnetic waves are guided in a single

beam to their destination by a wire, and the only serious loss is by leakage over the insulators along the line, or by imperfect conduction and internal warming of the line wire. In the other case, the power is scattered in every direction and only an extremely small fraction can be picked up and utilized at the distant receiving station. Nevertheless, the fact that a wire can be dispensed with is so wonderful, that we may be glad to obtain wireless telegraph communication at any reasonable cost, and not be over anxious to cavil at the waste of energy.

Spreading of Waves from the Sending Station

We have already seen that electromagnetic waves employed in wireless telegraphy start off as hemispherical waves, expanding at light-speed in all directions. The hemispherical formation fairly commences about a half-wave length from the sending antenna. Inside that radius the wave is much more complex in form. Theoretically, the expansion goes on indefinitely, allowing for the curvature of the earth. Practically, very little has yet been determined about the matter, except that signals from a sending antenna have been detected in balloons at moderate elevations above the earth not far from the antenna, and also by observers on the earth at a distance not

exceeding 5,000 kilometers (3,000 miles) in any direction. No receptions of messages have been yet reported over a greater distance than this.

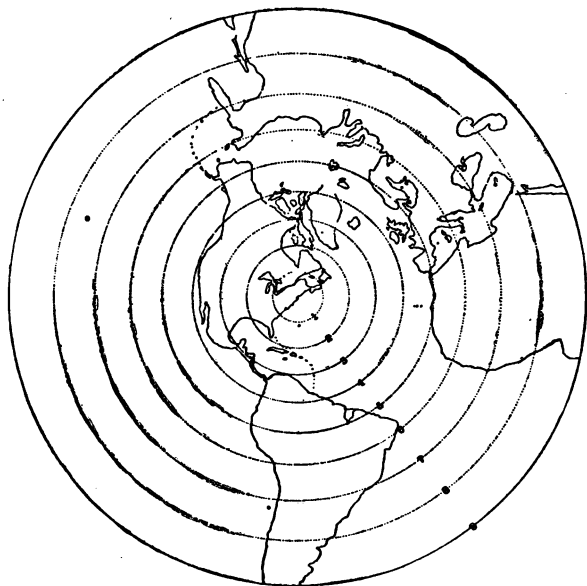

FIG. 56.—The Boston Hemisphere of the Globe in Stereographic Projection; or the Hemisphere with Boston as Pole.

Fig. 56 represents the spreading of the waves from the sending station according to the existing theory. The sending station is supposed to be located at Boston, Mass., which is,

therefore, placed at the pole of the earth, for the purpose of this discussion. Each of the dotted circles 1, 2, 3, . . . 9 represents an over-sea distance of ten degrees, or 600 nautical miles (1,111 kilometers or 690 statute miles). In passing from one circle to the next, the waves will take $\frac{1}{270}$ th of a second, or 3,700 microseconds. The complete journey from Boston at the pole, to the equator on circle 9, or one-quarter round the world, would occupy $\frac{1}{80}$ th second. It will be observed that the outgoing waves strike Newfoundland, Bermuda and the Great Lakes, about the same instant, $\frac{1}{270}$ th of a second after being emitted. Cuba and the Greenland coast would be struck almost simultaneously in $\frac{2}{70}$ ths second. When the waves reach England, in about $\frac{4}{70}$ ths second, they will also be striking Alaska, the Pacific coast, Norway, France, Spain, Morocco and the Brazilian shore. They will also nearly have reached the North Pole. After $\frac{8}{70}$ ths second, Japan, Thibet, Persia, Egypt, the Gold Coast, Argentina and Peru will be reached almost simultaneously. The corresponding development of the waves, in section through the center of the globe and the sending station, is presented in Fig. 57. Boston would occupy the position P, and a point on the ocean south of Perth, Australia, would occupy the antipodes P'.

The expanding waves would occupy the successive shells 111, 222, 333, and 444, the last being attained in $\frac{1}{15}$ th of a second. The equatorial circle Q 222 Q corresponds to the circle 9 in

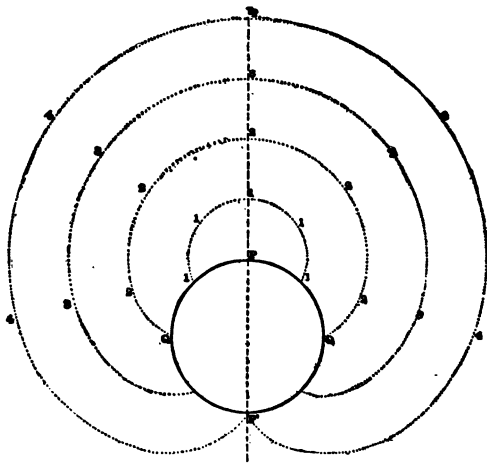

FIG. 57.—Hypothetical Expansion of Wireless Telegraph Waves Over the Globe.

Figure 56. It will be observed that after the wave passes the equatorial circle Q Q, it narrows its circle, and when it reaches the antipodes P', it has gathered all its feet to this point. This should mean that the weakening of the waves, which occurs by expansion at the outset, diminishes slightly on the surface of the globe after

passing the equator, and the signals at the antipodes P' should be relatively stronger than at other points in that region. All this is, however, as yet entirely inferential, because the waves have not yet been detected beyond the first position 1, 1, about one-eighth of the distance around the globe, or half way to the equator.

Moreover, it is uncertain as to what happens to the expanding waves in the upper regions of the earth's atmosphere, where no balloon can ascend to take observations. Air is an excellent insulator at ordinary pressures; but when air is exhausted from a vacuum-tube, the dregs of air remaining within can be made to conduct electric discharges better than sea-water. The pressure of the air is a maximum at the earth's surface, and dwindles indefinitely as the earth's surface is departed from. At an elevation of from 20 to 100 kilometers above the earth (12 to 60 miles), depending upon local conditions, there must be strata of rarified air having as low a density as that produced in such vacuum-tubes. It is uncertain whether very feeble electric forces can evoke conduction in such rarified air. That is to say, it is quite possible that conduction may occur in laboratory vacuum-tubes after the rarified air has been modified, or *ionised* as it is called—by the action of a relative powerful elec-

tric flux, and that in the absence of such degrees of electric flux-density, the rarified air would fail to conduct. If there is a shell of rarified air above the earth at a height of, say, 70 kilometers (roughly 40 miles) which suddenly conducts like sea-water, then the electric flux would cease to expand into the space beyond, but would skim along the interior wall of this conducting shell. The waves would then be confined to expansion sideways between the earth's conducting surface below and the internal wall of the concentric globe of rarified air above. This would tend to reduce the attenuation or weakening of the waves markedly; because beyond the radius of 70 kilometers, the expansion would continue in but two dimensions—longways and sideways—instead of three dimensions—including height. On the other hand, however, there might be layers of rarified air which conducted even under very feeble electric flux, and yet the conduction might be gradual instead of sudden. If the conduction increased gradually to a maximum through many kilometers of ascent, there would be loss of energy by reason of imperfect conduction and eddy-currents in the transitional layers, so that the benefit due to ultimate confinement of the waves within the rarified shells, might be more than lost by waste of energy in this partial conduction.

The whole subject of wave contour at great distances must remain in abeyance until sufficient measurements have been made of the wave-strengths at different distances to enable the contours to be inferred. Very little information is yet obtainable as to relative wave-strengths at great distances, partly owing to the difficulty of measuring extremely feeble wave-intensities and partly owing to atmospheric variations, to be referred to later. At short distances, *i.e.*, 100 kilometers (about 60 miles) or less, the few results obtained appear to indicate that the energy received diminishes roughly as the inverse square of the distance, or in conformity with simple hemispherical expansion.

Experimental Apparatus for a Range of a Few Meters

For simple experimental and demonstrative purposes, apparatus is readily obtainable that will produce recognizable signals at very short range and with an insignificant expenditure of power. The apparatus of Fig. 58 consists of a small induction coil with vibrator, to which the primary current from an external voltaic battery is admitted by the Morse key K. The terminals T t are for connection to a voltaic battery. The secondary winding of the induction-coil charges

the insulated double-rod system R R. By this means short waves are thrown off which strike



FIG. 58.—Simple Form of Wireless Sending Apparatus for Transmitting to a Distance of a Few Metres.

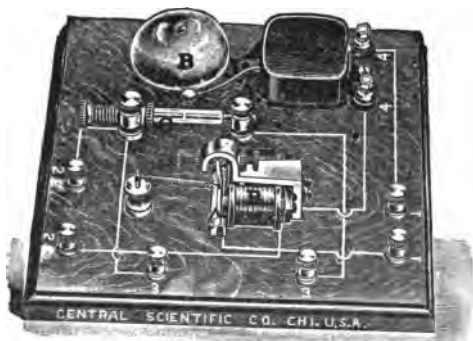

FIG. 59.—Receiver for Experimental Wireless Telegraph Set of Few Metres Range.

the receiver in the vicinity. A form of receiving apparatus capable of being used with such a set is indicated in Fig. 59. Here the horizontal

glass-tube coherer C is connected to the binding-posts 3, 3 on the wooden base. Short projecting wires may be clamped in these to help seize the passing waves. A voltaic cell is also connected through binding posts 2, 2 with the coherer, through the relay R. This relay is actuated when the coherer responds, and closes a local circuit through the vibrating electric bell B and

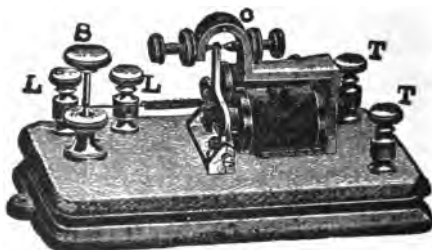

FIG. 60.—Simple Neutral Relay.

another voltaic cell connected to binding-posts 1, 1. The ringing of the bell not only gives the signal, but also agitates the coherer and restores its normal insulation, after the passage of the wave.

The relay R is represented in greater detail in Fig. 60. A pair of electromagnetic coils M are wound with silk-covered fine copper wire connected at the ends to the main terminals T T. The armature of the relay is free to move about a

horizontal axis through a small play, set by the two uppermost opposing screws. A spiral spring adjusted in tension by the set-screw S, draws the armature away from the electromagnetic poles, when these are unexcited by electric current in the coils. The armature lever then rests against an insulating stop. On being attracted by the magnet poles, the lever strikes the contact point



FIG. 61.—Polarised Relay.

C, thus completing a local circuit through the terminals L L, and wires to the same underneath the base.

In long-distance wireless telegraphy with the coherer, a more delicate form of relay is generally employed, such as that shown in Fig. 61. In this form the delicate lever plays, under glass cover, about a vertical axis and the adjustment is provided by the screw on the side.

The simple apparatus of Figs. 58 and 59 for sending messages across a hall, or from one building to another near by, is of some practical importance, because a wireless telegraph station equipped to receive messages over a distance of hundreds of kilometers or miles may not disdain

to employ an even still simpler apparatus of the same character, for testing purposes. An ordinary vibrating electric bell, such as that shown at B in Fig. 59, when excited by a voltaic cell, rapidly makes and breaks its circuit at the contact point of the vibrator. Each such interruption is usually accompanied by a little spark at the vibrator contact, and a feeble electric wave, or very brief wave-train is thrown off from the circuit. Such an apparatus may be installed, say, on the wall of the wireless telegraph station, and excited by pressing an ordinary push button at the receiving operator's desk. The operator wishing to ascertain whether his receiving apparatus is in order, may do so in the absence of any incoming signals, by pressing the bell-button. The feeble electromagnetic waves thrown off from the bell wires are thus enabled to attach themselves to the antenna wire or wires, and so to produce a feeble signal that the operator can recognize.

CHAPTER XII

TUNED OR SELECTIVE SIGNALING SYSTEMS

The Problem of Selective Signaling

IN the last chapter we considered wireless telegraph working between two stations to the exclusion of all others within the working range. But the earth's atmosphere is no longer an Eden with but a single pair of occupants. In most parts of the civilized world, the actual problem is how to communicate with the station that is wanted, and yet to keep out of communication with disinterested stations.

Nature of Interference

When a ship carrying an ordinary untuned coherer receiving set occupies a position at which wave signals are passing from only one sending station, the coherer is able to transmit those signals correctly to the Morse sounder, or ink-writer, in its local circuit. The same may be true if there are two sending stations working simultaneously, one of which produces much

more powerful wave signals, at the ship's position, than the other. The adjustment of the coherer may be such that the signals which are feebler, either owing to greater distance, or weaker transmitting apparatus, are unable to interfere, and only the stronger signals are recorded on board the ship. If, however, there are two or more stations in the neighborhood sending signals simultaneously, and the intersecting waves from these stations are about equally strong, the ship's coherer tends to respond to all of the signals, or to give an unintelligible mixed record. It is true that if the waves from the different competing sending stations have different lengths, that length of wave which most nearly conforms to the quadruple of the equivalent ship's antenna height will preponderate in strength. Nevertheless, in an untuned system, the other waves are likely to interfere. This is partly because, as we have already seen, a simple sending antenna, not tuned in connection with an auxiliary discharging condenser, tends to emit very short wave-trains, that are virtually but solitary waves with tails to them; and partly because a simple coherer, at the base of a simple receiving antenna, does not admit of much resonant building up of voltage, even with long wave-trains.

Auditory Selection

This interference and jumbling together of signals from different sending stations in the neighborhood was soon found to constitute a menace to wireless signalling on any extensive scale, especially with the coherer type of receiving instrument. With other types of receiver which operate through a telephone, less trouble from interference is liable to be felt. This is for the reason that in a telephone receiver the signals usually have a buzzing sound, or possess a definite semi-musical tone. The pitch of the tone corresponds to the frequency of the induction coil vibrator at the sending station; or, as it is termed, the *group-frequency*; *i.e.*, the number of impulses per second delivered to the sending induction coil when the sender's key is held down (see Fig. 33), or to the number of groups of waves emitted per second. As a general rule, different sending stations do not employ just the same group frequency, or pitch of vibrator, so that the characteristic buzz or tone of the signals heard in the receiving telephone is different for different stations. When, therefore, a number of stations are sending messages simultaneously in the neighborhood, an untuned receiving telephone set will render them all audible at once. If they

have all exactly the same tone, it would be impossible to make anything of the jumble of signals; but if, as usually happens, the tones are appreciably different, the conditions resemble the jumble of sounds maintained in a reception room, when many individuals are speaking close by at once. It is often possible, with a little effort, to focus attention on one particular succession of tones and mentally to read the signals they contain, to the exclusion of all the others.

Need for Resonant Selection

There is, however, a limit to the possibilities of deciphering one tone of telephonic signals from among a crowd. If a powerful antenna near a civilized seashore is connected untuned to a sensitive telephone employing receiver, a regular babel of signals is frequently to be heard. Some of these are from shore stations nearby, others from distant shore stations, and yet others from ships at sea. As we look upon the surface of a large lake, or of the sea, we usually discern waves or ripple trains, which are crossing, superposing, or intersecting in endless variation. A calm, unruffled water surface is the exception. The same conditions now apply to the atmospheric ether in civilized districts, so far as concerns long

electromagnetic waves. The atmospheric ocean is rarely quiescent.

Adjustment to Resonance

In order to bring about sharply selective signaling, it is necessary that the receiving antenna and apparatus connected therewith should be tuned to one definite wave-length, so as to respond to waves of that length exclusively, and also that the sending station desiring to communicate solely with that receiver should be tuned to emit as long wave-trains as possible, possessing this particular wave-length. Theoretically, it should be possible to adjust an antenna into resonance to a given wave-length within any desired degree of precision, so that if the waves received were one per cent. too short, or too long, they would fail to actuate the receiver. There is, however, a limit to precision in practical tuning for various reasons. About five per cent. above or below is usually regarded as satisfactory. That is, a receiving antenna and apparatus can be arranged to respond to a given wave-length of arriving signals, and not ordinarily to respond to waves five per cent. shorter or longer. This means that the receiver would not ordinarily recognize, or report in the telephone or recording

•

apparatus, any passing waves outside of these limits.

There are various ways of connecting, sending and receiving antenna circuits in order to tune them. One such way is indicated in Fig. 62 for the sending apparatus, and in Fig. 63 for the

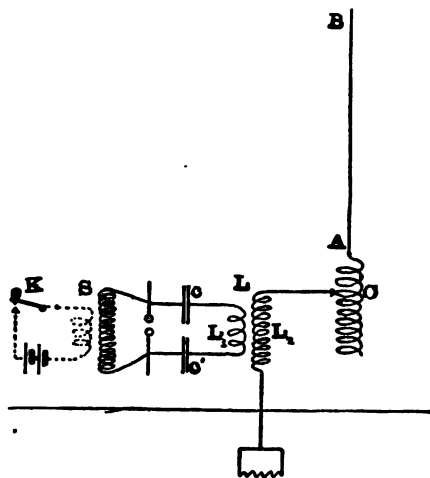

FIG. 62.—Particular Set of Tuned Sending Connections.

receiving apparatus. By means of a suitable switch, or group of switches, the change may be made from one set to the other, that is from sending to receiving, with one and the same antenna. Referring to Fig. 62, A B is the antenna or wire leading thereto, C an adjustable coil for virtually

altering the equivalent height and wave-length of the antenna. A high-frequency induction coil of relatively few turns without any iron core, is indicated at L , the secondary winding L_2 being connected to the antenna, and the primary L_1 to the secondary terminals of the spark coil S ,

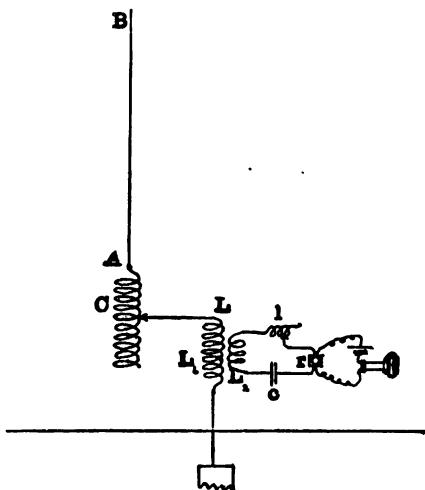

FIG. 63.—Particular Set of Tuned Receiving Connections.

through adjustable condensers c c' . The key K is in the primary circuit of the spark coil S .

The circuit s , c , L_1 , c' is adjusted to oscillate electrically at the required frequency and the antenna path B , A , C , L_2 is also adjusted to

oscillate at the same frequency. It generally results that there are at least two different frequencies, and not merely one frequency of oscillation set up in such a system; but one of the frequencies is taken as the effective or working frequency, and the others are regarded as ineffective or merely parasitical.

Turning now to the receiving connections of Fig. 63, A B is the antenna wire and C an adjustable coil as before. L is a high-frequency induction coil. In the secondary circuit of this coil is an adjustable small coil l, an adjustable condenser c, and the receiver r, connected with the local telephone, or recording instrument. The antenna path is adjusted to oscillate at the required frequency, and the secondary circuit L, l, c, r is also adjusted to oscillate at this frequency. Under these circumstances the whole receiving system is tuned to resonance with the single required frequency, or wave-length.

Simultaneous Sending and Receiving with Aid of Differential Resonance

When tuning is carefully and effectively carried out, it may enable remarkable results to be accomplished. For instance, it has been found possible to receive messages over an antenna at, say, the foremast of a steamer, and at the same

time to send messages in another wave-length, from an antenna at the mainmast, to a different and perhaps very distant station. It is evident that this result would not ordinarily be possible with simple untuned apparatus at both antennas, nor would it be possible with tuned apparatus, if the frequency and wave-length of both the sending mast and the receiving mast were the same.

Increase of Transmission Range by Means of Resonance

The advantages of tuning are found not only in the elimination of interference from extraneous signaling stations, but also in increase of sensibility and effective signaling range. The tuning of the sending station connections permits of increasing the length of the train of waves following each discharge of the spark coil. The sympathetic tuning of the receiving station connections permits of building up a resonant current strength in the receiver, due to the successive additions of impulses from the successive waves in the train. By this means, signals which would be too faint to be recognizable if they depended upon the impulse of a single wave, become recognizable by the cumulative impulses of a number of successive waves. There is good

reason, therefore, for expecting that when a suitable high-frequency dynamo is developed for the continuous maintenance of power in the sending circuit and antenna, a further great increase in effective range of transmission will be rendered possible.

Reduction of Atmospheric Disturbance by Means of Resonance

Another advantage derived from tuning is in the direction of minimizing the influence of atmospheric discharges. An antenna is a sort of lightning rod, and the taller and more extensive it is, the better atmospheric discharger it tends to become. The atmosphere contains electrically charged particles or free electric charges. Their presence may be accounted for in several ways that need not here be discussed. Consequently, an antenna is apt to receive a perpetual stream of little electric discharges from the layers of air near its top, to the ground at its base. This action is quite distinct from the much more powerful discharges which may occur over the antenna in the presence of a thunderstorm in the vicinity. During such a thunderstorm it is usually necessary to stop signaling and to keep the antenna grounded. The little atmospheric discharges become objectionably

noticeable in the receiver, and sometimes give rise to false signals. These continuous atmospheric disturbances are stated to be more noticeable and troublesome in the tropical than in the temperate zones, but they vary in intensity from day to day and hour to hour. On some occasions they are almost entirely absent, and on other occasions they are markedly prevalent. Distant thunderstorms and atmospheric discharges likewise produce noises in the receiving telephone, interfering more or less with received signals. Tuning of the antenna connections is capable of reducing atmospheric disturbances, although perhaps not of eliminating them entirely.

*Multiple Wireless Telegraphy by Means of
Resonance*

The results of tuning have even been carried further. It has been found possible to send two messages simultaneously over one and the same sending antenna, by connecting the antenna to two different coils, and auxiliary oscillating sending circuits, or to two different sections of one and the same coil. Again, it has been found possible to receive two messages simultaneously over the same receiving antenna by a corresponding connection to two oscillatory receiving cir-

cuits. This means that an antenna system may be arranged to emit two frequencies, or wave-lengths, simultaneously and independently. In the same way, one antenna may be arranged to resonate to each of two different frequencies or wave-lengths. By connecting a plurality of such oscillating circuits with an antenna, it is theoretically possible either to send or to receive an indefinite number of messages simultaneously, each in a definite appropriate wave-length. Up to the present time, however, but little use has been made of this possibility. A multiple system of wireless telegraphy is manifestly more complicated and difficult to maintain than a single system.

*Limitations of Communicability Through
Resonance*

Along with the advantages which pertain to a tuned or selective signaling system, there is one evident disadvantage, namely, loss of communicability. It is all very well for a ship which is tuned to receive waves say 300 meters (328 yards) long, or at a frequency of one million cycles per second, to be able to carry on communication with another ship, or a shore station, that uses the same wave-length; but a third station having a different tuning and producing waves, say 400

meters long, may desire to communicate with the ship, and not be able to do so, either from not knowing the particular wave-length to which the ship responds, or from not being able to alter his tuning thereto. It is partly for this reason that the ordinary wireless equipment on board ocean-going vessels is not sharply tuned. It is desirable that they should be able to speak to all comers within normal short range.

German Practice

Under the auspices of the German government a dozen stations along the German coast are all tuned to emit waves of 365 meters (398.5 yards) in length, corresponding approximately to a frequency of 820,000 cycles per second. These stations have a signaling range of about 200 kilometers (125 miles) between each other, or about 120 kilometers (75 miles) from any one shore station to ships in its neighborhood. The ships are also tuned to this wave-length. Under these conditions the shore stations take precedence. When a shore station calls, ships within range are instructed not to speak unless called. Ships are also instructed not to call a shore station needlessly, or beyond the normal 120 kilometer (75 miles) range. By the observance of such regulations mutual advantage is subserved,

as well as the keeping of ethereal peace. A wireless-telegraph etiquette is thus gradually becoming evolved.

Difficulties in the Way of Using Reflectors or Lenses for Wireless Light

It would clearly be of great advantage if, instead of radiating waves from a sending station to all the thirty-two points of the compass at once, there were some convenient means of channeling the waves into a beam, capable of being sent into any desired direction. This would not only save wasted power, but would also save needlessly stirring up the ether into noisy signals in outlying regions where other parties are trying to talk. At first sight it would seem that because we can readily accomplish this result with short-length luminous waves, as in the search-light beam for instance, we ought likewise to be able to accomplish it with the long waves of wireless telegraphy. The trouble is, however, that optics leads to the general law that both reflectors and lenses must be large with respect to the wave-length of the waves they bend into parallelism. Thus, with half-micron waves of light, a tiny mirror, no larger in diameter than one millimeter ($\frac{1}{25}$ inch), would cover 2,000 wave-lengths. If the mirror had a diameter of

less than half a micron ($\frac{1}{50000}$ inch) or less than a wave-length, it would fail to serve properly as a reflector. In the same way, when we deal with, say, 400-meter (437 yards) waves of invisible polarized light, it would take a metallic surface of more than 400 meters (437 yards) *square* to make a serviceable reflector, and such sizes are prohibitive. A sending station situated in front of a very steep overshadowing cliff, of fairly conducting surface, might have its shore side sheltered and its sea-going waves strengthened by the reflecting surface of the cliff; but such localities are not always forthcoming; nor perhaps is the surface soil sufficiently conducting to provide in most cases a satisfactory reflector. It is well known that a ship getting behind such a cliff may be sheltered on that side from arriving signals, or in other words that such cliffs may throw long electromagnetic shadows beyond them. On the other hand, a vessel lying in a harbor enclosed by hills which do not rise abruptly, but slope to the harbor, will often receive wireless messages from a direction over the hills, the waves in such cases running down over the slope.

Although no marked degree of success has hitherto attended the erection of reflecting verticals, or mirror surfaces, behind sending antennas, yet care has to be taken that a receiving

antenna is suspended reasonably clear of high conductors capable of casting a shadow. Thus a receiving antenna wire suspended behind a steamer's funnel of steel, or immediately behind a steel mast, would be likely to have its signals much weakened, if not entirely absorbed. For this reason an antenna is usually suspended from a rope between two masts, in such a manner as to hang free from both.

Some experimental progress toward the space direction of emitted waves has been recently announced by the addition of a horizontal antenna on the top of, and proceeding from, a vertical antenna. This construction is equivalent to taking say an 80-meter (87.5 yards) antenna, and instead of setting it entirely erect, placing 30 meters (32.8 yards) vertical and then carrying the remaining 50 meters (54.7 yards) out horizontally in a straight line overhead. In such a case the radiation is partly polarized in the horizontal plane, and partly in a vertical plane, the resultant being a sort of combination, or elliptical polarisation. Such waves are subject to different degrees of attenuation in different directions. It is found that the radiated waves are strongest in the direction opposite to that of the horizontal offset; so that this offset in the antenna should be made away from the direction

in which it is desired to send the waves. In the direction of the offset, the waves are weak and they are weakest of all in a direction nearly at right angles to the offset.

In time, it is to be hoped and expected that all large vessels will carry wireless telegraph apparatus, and that all lighthouse stations along the ocean shores will be equipped with invisible as well as visible beams. The invisible beams would be perceptible by electromagnetic apparatus far out at sea, and also in foggy or hazy weather. This system of coast protection for arriving vessels is already commencing.

*Desirability of Means for Determining Wave
Directions at Sea*

When a wirelessly equipped steamer approaches the coast of Europe or of America, she is apt to be apprised of the proximity of land in thick weather by the reception of signals from coast wireless stations. It is not easy to determine, however, the direction whence the signals come, or the bearing of the station. It would be advantageous to be able to orient the received signals, or to determine their direction of advance. By suspending two or more antennas far apart, near the bow and stern of the vessel respectively, and bringing them into communication through

suitably tuned apparatus, it might be possible by swinging the ship to find the approximate bearing of the shore station. When the antennas were in line with the station, the signals would reach a maximum (or minimum), and when the line joining them was at right angles to the bearing of the station, the opposite condition should occur. Such a procedure is, however, objectionable, since it requires the ship to be stopped for observations, or at least turned erratically off her course. It seems likely that the first method to be found available will be for each shore station to erect a system of radiating wires, and to determine the direction of the ship by tests conducted upon alternate wires or pairs of these wires. The shore might then inform the vessel of her bearing, which would be the next best to the ship's determining the shore station bearing herself.

CHAPTER XIII

MEASUREMENTS OF ELECTROMAGNETIC WAVES

Importance of Determining Wave-lengths

WE have already seen in Chapter VI that the length of the waves thrown off by a simple vertical rod oscillator, discharging into a perfectly conducting level ground, is four times the height of the rod; so that in the case of a simple unloaded antenna of the type represented in Fig. 26, we can form a close estimate of the wave-length emitted. But antennas are usually loaded by coils, condensers, or other apparatus, so that it becomes impossible to estimate their emitted wave-length with any degree of reliability. Moreover, the wave-length, which is not of great importance in simple untuned signaling, becomes of great practical importance in selective signaling by the aid of resonance. If we can readily measure the length of the waves thrown off by an antenna, we can proceed in a rational and straightforward way to tune the system, and also to produce any required wave-length within reach.

Method for Determining Wave-lengths.

The wave-length of an oscillating system is measured by bringing a portable, adjustable oscillation system into electromagnetic communication with it, and adjusting the portable system until resonance is observed therein. At resonance, the wave-length of the tested system and of the portable system is the same. The wave-length of the portable system is determined, or computed, from its adjustments, and the wave-length of the tested system therefore becomes known.

The simplest kind of an adjustable oscillating system consists of a circuit containing a coil of wire and a condenser. Either the coil may be adjustable in its length and virtual number of turns, or the condenser may be adjustable in the extent of its effective surface, or both may be adjustable independently. The electromagnetic length of a coil is conveniently measured and stated in centimeters or meters. The *capacity* of a condenser is also conveniently stated in the same units of length. When the oscillating circuit is adjusted to resonance, the length of its wave is the circumferential length of that circle whose radius is the geometric mean (square root of product) of the coil meters and condenser

meters. Thus, if the circuit was in resonance when the coil was adjusted to 1,000 meters, and the condenser to 40 meters, the geometric mean of these two lengths would be 200 meters and a circle with this radius would have a circumference of 1,257 meters (1,375 yards) which is the wavelength of the resonant circuit.

Means of Determining Resonant Condition in Portable Circuit

In order to recognize when the portable oscillation circuit has been adjusted to resonance, a *galvanometer, ammeter,* or current-indicator suitable for high-frequency to-and-fro currents, or oscillations is placed in the circuit. Fig. 64 shows one form of such an ammeter. It consists essentially of a short length of fine platinum wire, whose ends are secured to fixed supports. The center of the suspended wire is fastened to a thread that runs over a delicately supported pulley, carrying a pointer or index. If a rapidly oscillating electric current passes over the fine platinum wire, the wire is thereby heated and



FIG. 64.—Hot-Wire Ammeter or Current Measurer.

elongates. The elongation is detected by the sagging of the thread fastened to the center, and the degree of elongation, duly magnified, is caused to indicate the effective strength of the current. Care has to be taken that the current passing is not strong enough to overheat or melt the platinum wire. If such an instrument is inserted in a resonant oscillating circuit, the current indicated will become a maximum when resonance is produced.

Thermo-galvanometer

A much more sensitive galvanometer or current indicator depending also upon the heat produced by current in a fine wire, is seen in Fig. 65.



FIG. 65.—Delicate Thermo-Galvanometer.

A loop of fine platinum wire is supported close beneath, but not touching, the soldered junction of two wires of different metals, forming a circuit which is delicately suspended in a permanent magnetic field. When current passes through the fine platinum wire, some of the heat produced is communicated to the soldered junction. This raises the temperature of the junction and pro-

duces a steady *thermo-electric force* or voltage, as long as the elevation of temperature persists. The voltage sets up an electric current in the local circuit of the suspended loop, and the loop twists or tends to deflect sideways about the suspension, in a manner and to a degree which is greatly magnified by an attached mirror and a beam of light reflected therefrom. By means of this *thermo-galvanometer* very feeble oscillating currents may be measured. Some of the best measurements yet published concerning the strength of signals received at different distances from the sending station have been obtained by its use.

Disk Galvanometer.

Another form of high-frequency galvanometer is indicated in Fig. 66. It consists of a coil of insulated wire having comparatively few turns, and supported at the center of the instrument, connected in the circuit under test. Inside this fixed coil is delicately suspended a little silver disk *s*, to which is attached a small mirror *m*, the two being carried on a fine quartz fiber about 30 cms. (12 inches) long. The suspension is illustrated separately in the figure. When a high-frequency current alternates in the fixed coil, a feeble alternating current of the same frequency

is set up in the silver disk, and the electromagnetic attraction between the current in the coil and the current in the disk causes the disk to twist, or



FIG. 66.—Oscillating-Current Galvanometer.

deflect about the axis of suspension. The deflection is magnified and rendered measurable by a beam of light reflected from the mirror *m*.

The portable oscillation circuit is brought into electromagnetic communication with the tested circuit, either by actual contact at two close points, or by means of a little induction coil of very few turns.

Wave-measuring Helix

Another type of portable resonant circuit is made in the form of a helix, or close spiral, of fine wire wound upon an insulating rod or cylinder. Such a circuit has a greatly reduced or minified wave-length. That is, a wave which would occupy a length of say 50 meters (54.7 yards) of straight wire, would perhaps occupy only 15 centimeters (6 inches) of this wire wound in a curl or helix. When the antenna to be tested is in excitation, one end of this helix is presented near to but not touching the antenna, and the length of helix which will set up resonance is ascertained by running a grounded conductor along it. Resonance is in this case detected by the formation of a glow or brush discharge, either from the end of the helix itself, or within a small vacuum-tube placed adjacent thereto. A scale marked along the rod then enables the observer to read off the wave-length directly.

CHAPTER XIV

INDUSTRIAL WIRELESS TELEGRAPHY

The Ocean, the Kingdom of Wireless Telegraphy

WIRELESS telegraphy has already come into widely extended use over the ocean. It has not come as yet into extended use over land. The reasons for this are evident: Wire telegraphy has already held undisputed sway over land. Wherever there has been developed urgent demand for the telegraph, the wire has been run to meet it. But a moving ship cannot keep up wire communication with the land, except in the rare instances where a ship is employed in laying a submarine cable. Consequently, wireless telegraphy has absolutely undisputed sway over the surface of the ocean in reaching ships at a distance, or in reaching ships near by, when visual signals cannot be read, as at night, or in fog. Already, wireless telegraphy has done splendid work in maintaining communication with ships at sea. In a certain sense wireless telegraphy has removed the sea, because the sense of isolation in a vessel out of sight of land is almost entirely lost

when messages are received on board through the ethereal medium of the air. In a psychological sense, distance has been destroyed. Moreover, since the sea is the conducting medium or broad conductor for guiding wireless telegrams, we may say that the sea has ceased to divide countries and now connects them.

Prospects of Submarine Cable Telegraphy

It has been much debated whether wireless telegraphy would render submarine telegraph cables useless and cable property valueless. Up to the present time it has not done so, and there is no immediate prospect of its doing so. Taking, for example, the islands of Great Britain and Ireland, these are electrically connected with North America by thirteen submarine cables, and with South America by three more. Altogether there are about sixty wires connecting Great Britain with other countries. These cables are pouring messages into the islands at an average rate each of, say, fifteen words per minute, day and night continuously. It would be an enormous undertaking to replace these cables by wireless telegraphy, without any reference to all the other parts of the world served by submarine cables. Up to this date, wireless telegraphy has probably aided submarine cables

by bringing telegraph messages to and from ships at sea, for transmission by cable, more than it has injured cable telegraphy by sending messages over the sea that would otherwise have gone underneath. On the other hand, however, it must be remembered that wireless telegraphy is still very young, and that it has already made far more progress in its brief lifetime than did wire telegraphy in the corresponding period of its life, sixty to seventy years ago. If wireless telegraphy continues to advance in the future at the rate it has maintained in the past, it may be that at some distant future time submarine cables will cease to be laid, and their work surrendered to their wireless rival.

There has been already at least one case where wireless telegraphy has supplanted a submarine cable, and that is between the U. S. army stations of Fort St. Michaels and Safety Harbor, Cape Nome, across Norton Sound on the coast of Alaska, a distance of about 177 kilometers (110 miles). The cable having been repeatedly broken by ice on this ice-bound coast, the telegraph service has been carried on for about two years continuously by wireless telegraphy.

There are also several short sea distances between islands, or between islands and mainland, which have recently been covered by wireless

telegraph equipments instead of by submarine cable. One of these is between Port Blair on the Andaman Islands and the mainland, Burma, a distance of 491.1 kilometers (305.2 miles) under the auspices of the Indian government telegraph department, the traffic averaging about ninety messages per month each way. On the other hand, a number of important long submarine cables have been laid since the introduction of wireless telegraphy.

*Peculiar Difficulties Incident to Wireless
Telegraphy.*

One of the difficulties that long-distance wireless telegraphy has had to deal with, which will probably always have to be expected, is disturbance from thunderstorms in the vicinity of a station. Such visitations are not rare during summer seasons, and usually call for a temporary suspension of traffic.

A curious lesser difficulty that long-distance wireless telegraphy has to meet is the effect of sunlight upon the atmosphere. Messages can be sent and signals received much further by night than by day. The effect of sunlight on the atmosphere is apparently to make the air foggy for the long waves of invisible wireless light. The nature of the action has not yet been clearly

demonstrated; but it is supposed that the energy of sunlight, or short-wave light, in impinging upon the ocean of air, either disrupts many air-atoms and ionises them, or else injects streams of ionised matter from the sun, thereby leaving floating electric charges in the air. The passage of electric waves through ionised air causes work to be done in displacing the electrons, or electric charges, and such energy is absorbed from the stock of energy in the waves. The waves therefore become enfeebled, or absorbed, in a manner suggesting the action of fog upon ordinary light. The degree of enfeeblement during daylight hours is not uniform, and varies from day to day in a most fluctuating and apparently erratic manner. This means that in order to carry on wireless telegraph service during the worst atmospheric daytime conditions, there must be a considerable reserve of power over and above that necessary during the night time under the best conditions.

Extent of Use of Wireless Telegraphy on Vessels

A large number of naval vessels of different governments are now equipped with wireless telegraph apparatus. Wireless telegraphy played a conspicuous part in the naval maneuvers of the Russo-Japanese war. By its means a blockade

was sustained of Port Arthur for many months by a Japanese fleet at a safe anchorage a considerable distance away.

Wireless telegraphy equipment has been placed on board steamers of the following lines:

- The Cunard Steamship Co.
- The Norddeutscher Lloyd Co.
- The American Line Co.
- The Allan Line Co.
- The Atlantic Transport Co.
- The Compagnie Transatlantique.
- The Red Star Line.
- The White Star Line
- The Hamburg-American Line.

About seventy vessels of this transatlantic fleet are so equipped, of which some thirteen carry long-distance tuned equipments in addition. There are two powerful wireless transmitting stations on the shores of the North Atlantic Ocean, one at Cape Cod, Mass., and the other at Poldhu in Cornwall. It is becoming customary for a vessel with a long-distance equipment to maintain communication across the Atlantic with one of these stations until she establishes communication with the other; so that at no time is she outside the range of communication.

A wirelessly equipped vessel leaving New York

is in communication with the station at Sea Gate, N. Y. This is carried until it is exchanged for communication with Babylon, L. I. This is carried until Sagaponack, L. I. Next Nantucket Mass., is taken, then Sable Island, and finally Cape Race. Communication for the exchange of messages is thus maintained for about seventy hours after leaving port, each of these stations being in permanent wire communication with the rest of the world.

It is stated that in the year prior to Jan. 31, 1906, these American stations sent and received, with ships, altogether 15,000 messages comprising over 200,000 words.

Number of Land Wireless Stations

According to a report of the U. S. Navy Department there are this year (1906) nearly 300 land wireless stations in different parts of the world, namely:—

Belgium 1	Roumania 2	Cuba 1
Denmark 4	Russia 8	Tobagol 2
Germany 13	Sweden 3	E. India 4
France 6	Turkey 6	Burma 1
Great Britain 43	Argentina 5	Hong-Kong 1
Holland 8	Brazil 5	China 5
Spain 4	Canada 20	Hawaii 6
Portugal 1	Chili 1	Japan 2
Gibraltar 2	Colombia 1	Dutch E. Ind. 5
Italy 18	Costa Rica 3	Asiatic Russia 1
Malta 1	Mexico 2	Egypt 2
Montenegro 1	Panama 3	Morocco 2
Norway 1	United States 98	Mozambique 2
Austria-Hung. 2	Trinidad 1	Tripoli 1

According to the same navy department list, there are at this date some 144 mercantile vessels equipped for wireless telegraphy, including the Atlantic liners already referred to, and carrying flags of the following countries:

Belgium	14	Holland.....	7
Germany.....	17	Italy.....	7
France.....	7	United States.....	62
Great Britain....	26	Canada.....	4

The total number of recorded ship and shore stations is thus about 440, exclusive of many warships of various nations.

Each station possesses a definite "code-name" or "call-letter," which is usually a group of two, or even three, letters, such as BA (Babylon, L. I.). Stations are called by their code names and they sign their messages with them. This is even more necessary in wireless than in wire telegraphy; because the distant station may be far beyond visible range, and be otherwise unidentified.

It is customary for a steamer to pick up communication with another steamer at a distance of say 50 kilometers (26.6 nautical miles, or 31 statute miles) and to carry on communication until the distance between the ships is, say, 120 kilometers (64 nautical miles or 75 statute miles). Occasionally, however, messages are exchanged between a ship and shore at much greater distances than these.



INDEX OF SUBJECTS

A		PAGE
Activity of antenna. . .	100	
Air, Sound-Waves in. . .	5	
Alphabets, Morse.	153	
Alternating-current accom- panying radiat- ed wave.	47	
Alternating - current dynamo.	105	
Ammeter.	193	
Amplitude of sound- waves.	10	
Antenna.	97	
Antenna, Activity of	100	
Antenna, Essential ele- ments of.	98	
Antenna, loaded, In- ternal reflections in.	123	
Antennas, Cylindrical.	102	
Antennas, Fan.	103	
Antennas, Harp.	103	
Antennas, Heights of.	158	
Antennas, Insulation of.	157	
Antennas, Inverted- cone.	103	
Antennas, Loaded.	120	
Antennas, Multiple- wire.	101	
Antennas, Single-wire.	101	
Auditory selection.	175	
Auxiliary condenser. . .	115	
C		
Capacity of condenser. .	116	
Circuit, Local, of re- ceiver.	127	
Circuit, Portable.	193	
Classification of elec- tromagnetic waves. . .	74	
Coherers.	125	
Coil, Self-induction of. .	122	
Comparison of receiv- ers.	145	
Condensation of fluxes toward equatorial zone.	61	
Condenser, Auxiliary. . .	115	
Condenser, Nature of. . .	116	
Consonance, Electric. . .	118	
Counter-electromotive- force of polarization	139	
Current-detectors.	124	
Cylindrical antennas. . .	102	
D		
Decohering, Mechni- cal.	129	
Depolarizing of elec- trodes.	138	
Detectors, Current.	124	
Detectors, Electrolytic	125	
Detectors, Electromag- netic.	125	
Detectors, Thermal.	125	
Detectors, Voltage.	124	
Deviation of waves from hemispherical form.	60	
Diminution of intensity in sound-waves.	8	
Directing wireless tele- graph waves.	186	

	PAGE		PAGE
Discontinuity of coil- fed antenna oscilla- tions.	113	Electrodes.	140
Disk galvanometer.	195	Electrolyte, Definition of	137
Dynamo, Alternating- current.	105	Electrolytic detectors.	125
		Electromagnetic detec- tors.	125
E		Electromagnetics, and optics.	73
Earth's Surfaces, Im- perfect conduction of	48	Electromagnetic waves and polarized light.	67
Eddy currents in sur- face of earth or sea.	78	Electromagnetic waves Classification of.	74
Electric and magnetic fluxes, Tensions in.	26	Electromagnetic wave- detectors.	124
Electric and magnetic forces in moving waves.	79	Electromagnetic-wave, Energy of.	33
Electric consonance.	118	Electromagnetic waves Hemispherical.	59
Electric conductors, Resonance in.	90	Electromagnetic waves Measurements of.	191
Electric Field.	25	Electromagnetic wave, Nature of.	31
Electric Flux and its properties.	23	Electromagnetic waves Plane.	75
Electric Flux, Energy of.	24	Electromagnetic wave, Radiation of.	40
Electric Flux, move- ment over conduc- tors.	29	Electromagnetic waves Speed of.	33
Electric Flux, Proper- ties of.	23	Electromagnetic waves Spherical.	64
Electric Flux, Provi- sional hypothesis concerning nature of Electric oscillations, Skin depth of.	105	Electromagnetic wave- trains.	48
Electric Resonance.	91	Electromotive force.	85
Electric Strength of in- sulators.	117	Energy in waves.	4
Electricity and magne- tism, Nature of.	16	Energy of Electric Flux Energy of Electromag- netic waves.	24
Electric theory of mat- ter.	68	Energy of Magnetic Flux.	21
		Energy of received elec- tric oscillations.	94
		Energy of Wind.	14
		Equatorial zone, Con- densation of fluxes toward.	61

INDEX OF SUBJECTS

209

Ether, Assumption of
The. 15

F

Fan antennas. 103
Free Ocean Waves. 3
Frequency, Group. 175
Frequency, Relations
to wave length and
periodic time. 62

G

Galvanometer, High-
frequency. 195
Gashes in waves, torn
by vertical conduc-
tors. 85
German practice. 185
Group frequency. 175
Guided electromag-
netic waves. 35

H

Harp antennas. 103
Heights of antennas. . 158
Helix, wave-measuring 197
Hemispherical electro-
magnetic waves. 59
High-frequency gal-
vanometer. 195
Hot-wire receivers. . . . 132

I

Image, Electric. 38
Impact of waves
against vertical con-
ductors. 92
Imperfect Conduction
of earth. 48
Induction coil for high
voltage. 107

PAGE

Industrial wireless tel-
egraphy. 198
Insulation of antennas 157
Insulators, Electric
strength of. 117
Intensity in sound-
waves, Diminution
of. 8
Internal reflections in
loaded antenna. 123
Inverted-cone anten-
nas. 103
Ionizing of rarefied air. 166

K

Krakatoa explosion. . . . 11

L

Light, Plane-polarized 72
Loaded antennas. 120
Local circuit of receiver 127

M

Magnetic and electric
fluxes, Tensions in. . 26
Magnetic and electric.
forces in moving
waves. 79
Magnetic Flux and its
Properties. 18
Magnetic Flux Created
by Moving Electric
Flux. 30
Magnetic Flux, Energy
of. 21
Magnetism and elec-
tricity, Nature of. . . 16
Matter, Electric theory
of. 68
Measurements of elec-
tromagnetic waves. 191
Mechanical decohering 129

	PAGE	R	PAGE
Micron, a unit of length.....	68	Radiation of electromagnetic waves....	40
Microsecond, Unit of time.....	99	Received electric oscillations, Energy of..	94
Mnemonic rules for directions of fluxes in waves.....	52	Receivers, Comparison of.....	145
Morse alphabets.....	153	Receivers, Wireless telegraph.....	124
Morse inkwriter.....	146	Relations between wave-length, frequency, and periodic time.....	62
Multiple-wire antennas	101	Relay, Electromagnetic.....	130, 170
Multiple wireless telegraphy.....	183	Resonance in electric conductors.....	90
		Resonant selection....	176
N			
Non-conductors, Transparency of.....	79		
O		S	
Ocean Waves, Free....	73	Selective signalling....	173
Optics and electromagnetics.....	93	Self-induction of coil..	122
Oscillating-current galvanometer.....	196	Sending apparatus, elements of.....	110
Oscillating currents in receiving verticals..	94	Sending keys.....	151
Oscillator, Simple vertical.....	49	Shadow cast by electric conductors.....	80
		Short-range apparatus	168
		Signalling range on sea and land.....	86
		Simple vertical oscillator.....	49
		Simultaneous sending and receiving.....	180
		Single-wire antennas..	101
		Skin depth of electric oscillations.....	105
		Sound-wave Trains ...	11
		Sound-waves, Amplitude of.....	10
		Sound-waves, Diminution of intensity in..	8
		Sound-waves in air...	5
		Sound-waves, Speed of	8
P			
Periodic time, relations to wave-length and frequency.....	62		
Plane electromagnetic waves.....	75		
Plane-polarized light..	72		
Polarized light and electromagnetic waves..	67		
Portable circuit.....	193		
Power required for wireless telegraph sending.....	160		

INDEX OF SUBJECTS

211

	PAGE		PAGE
Speed of electro-magnetic waves.	33	Vertical oscillator, Essential elements of. . .	98
Speed of sound-waves.	8	Vertical oscillator, Simple.	49
Spherical electromagnetic wave.	64	Voltage.	108
Spreading of wireless-telegraph waves.	162	Voltage-detectors.	124
Sunlight, Effect on wireless telegraphy of.	201	W	
T			
Telephone receivers.	147	Wave-detectors, Electromagnetic.	124
Tensions in electric and magnetic fluxes.	26	Wave-length, Relations to frequency and periodic time.	62
Thermal detectors.	125	Wave-lengths, Determination of.	191
Thermo-electric force.	195	Wave-lengths, in ocean waves.	4
Thermo-galvanometer	194	Wave-measuring helix	197
Transparency of electric non-conductors.	79	Wave trains, Electromagnetic.	48
Tuned signalling.	173	Wind energy.	14
U			
Unguided electromagnetic waves.	64	Wireless-telegraph interference	173
V			
Vertical conductors, Impact of waves against.	92	Wireless-telegraph receivers.	124
		Wireless-telegraphy, Industrial.	198
		Wireless-telegraphy on vessels.	202
		Wireless-telegraph stations, Number of.	204
		Wireless-telegraph waves, Spreading of.	162



